

Firestone



World's Number 1
Air Spring.



FIRESTONE INDUSTRIAL PRODUCTS COMPANY

MARSH MELLOW™

SPRINGS

Vibration Isolation Design Manual



www.fsip.com

MMDM108

Table of Contents

Table of Contents and Introduction	2	Individual Data Sheet	12
Advantages	3	Part Number	12
Precautions	4	Table of Dynamic Characteristics	12
Temperature	4	Marsh Mellow and Mounting Pin Dimensions.....	12
Design Envelope	4	Load/Deflection Curve	13
Contaminates	4	Selection Procedure (Imperial)	14
Storage	4	Vibration Isolation Selection	14
Percent Compression	4	Vibration Isolation Selection Example.....	15
Allowable Stroke.....	4	Shock Impact Selection	18
Disturbing Frequency Range.....	4	Selection Procedure (Metric)	19
Lateral Stability	4	Vibration Isolation Selection	19
Center of Gravity	5	Vibration Isolation Selection Example.....	20
Startup and Shutdown/Resonance and Amplification .	5	Shock Impact Selection	23
Isolating an Unbalanced Mass	5	Installation	24
Construction	6	Vibration Isolation New Installation	24
Solid Rubber Core Material	6	Coil Spring Replacement.....	25
Hollow Center.....	6	Miscellaneous Mounting Arrangements	26
Fabric Reinforcement.....	6	Applications	27
Marsh Mellow Dynamic Characteristics	7	Vibration Isolation.....	27
Vibration Isolation.....	7	Shock Impact.....	27
Natural Frequency	8	Tag Line.....	27
Disturbing Frequency.....	8	Selection Guide (Imperial)	28
Transmissibility.....	8	Load Requirements.....	28
Isolation	8	Stroke Requirements	29
Resonance	9	Selection Guide (Metric)	30
Amplification.....	9	Load Requirements.....	30
Amplitude	9	Stroke Requirements	31
Stroke	9	Individual Data Pages	32-58
Strain	9	Design Parameter Sheet	59
Isolating an Unbalanced Mass	10		
Shock Impact.....	11		

Introduction

Marsh Mellow™ is the trade name of the fabric and rubber spring developed by Firestone Industrial Products in the early 1970's. Rubber springs have long been a subject of interest in the vehicular suspension and industrial application fields because of their reliability, corrosion resistance, low cost, and basic simplicity. The concept has been tried with varying degrees of success over the years. The major obstacle to solid rubber springs has been that to obtain the load requirements for many applications, solid rubber springs were either physically too large, or became unstable laterally when they were made long enough to provide good isolation. The concept of "stacking" rubber springs answered the latter problem, but introduced the need for complicated mechanical guide systems to control the lateral movement.

The Marsh Mellow fabric and rubber spring solves this basic problem and provides a new and unique way to make use of the many advantages of rubber as an isolator. The basic construction of the Marsh Mellow spring includes a solid rubber core with a hollow center, and fabric reinforced body. The controllable variables of this construction are the keys to the extreme design flexibility that the spring offers.

Please Note:

The information contained in this publication is intended to provide a general guide to the characteristics and applications of these products. The material, herein, was developed through engineering design and development, testing and actual applications and is believed to be reliable and accurate. Firestone, however, makes no warranty, expressed or implied, of this information. Anyone making use of this material does so at his own risk and assumes all liability resulting from such use. It is suggested that competent professional assistance be employed for specific applications.

Advantages of Firestone Marsh Mellow™ Springs



Constant Vibration Isolation with Changing Loads

The variable spring rate allows for a nearly constant natural frequency with changing loads. This results in consistent vibration isolation with variable loading.

High Load Carrying Capacity

Due to the Marsh Mellow spring's greater deflection capabilities and load carrying influences of the fabric reinforcement, it can carry a greater load when compared to an all rubber part of the same modulus and dimensions.

Excellent Vibration Isolation

Low natural frequencies provide excellent isolation of forced frequencies in the range of 800-1200 cycles per minute (13-20Hz).

Lateral Vibration Isolation

The lateral spring rate of a Marsh Mellow spring can be less than the vertical spring rate, resulting in a lower lateral natural frequency. Marsh Mellow springs provide better vibration isolation in all degrees of freedom.

Compact Overall Size

The ability to support greater loads and maintain a cylindrical shape results in a smaller overall size of the Marsh Mellow spring compared to an all rubber spring with identical load capacity. This is important when considering an application with a small design envelope.

Corrosion Resistant for a Durable, Long Life

Due to its rubber and fabric reinforced construction, the Marsh Mellow spring has been proven in the damp and corrosive environments of mines and mills where a standard coil spring will fail.

Does Not Bottom-Out

Due to the rubber construction, Marsh Mellow springs do not bottom-out like coil springs. Bottoming-out under overload or surge load sends a large amount of stress to all of the machine's components.

Eliminates Downtime and Potential Damage to Machinery

When a coil spring fails, it will often crack allowing fragments of the coil to damage equipment. This problem is eliminated with the rubber construction of Marsh Mellow springs. Additionally, Marsh Mellow springs exhibit exceptionally high overload characteristics and usually do not fail catastrophically, offering some support even during failure.

Increased Stability at Higher Percentages of Compression

Rubber is an incompressible fluid which will flow to the path of least resistance. In a Marsh Mellow, as the height compresses, the fabric reinforced rubber plies pantograph and the diameter grows. This supports the rubber core laterally even at 30-40% compression.

Effective Noise Reduction

Marsh Mellow springs reduce structurally transmitted noise caused by vibration. Marsh Mellow springs are quiet, unlike steel springs which often suffer coil chatter and readily transmit high frequency structural noise.

Low Cost

The Marsh Mellow spring's high load capability means fewer springs may be needed in an application, resulting in less overall cost.

Maintenance Free

Marsh Mellow springs have no moving parts. No maintenance or lubrication is required.

Precautions with Marsh Mellow™ Springs

Temperature

Our standard industrial Marsh Mellow™ springs have an operating range of -40°F to 135°F (-40°C to 57°C). The upper limit is defined by the actual rubber temperature during operation. High frequency inputs or large deflections will cause the rubber temperature to increase.

Design Envelope

Adequate clearance should be provided around the Marsh Mellow spring to prevent rubbing of the outer cover. The outside diameter of the spring at various heights is listed in the table of dynamic characteristics on each individual data page.

Contaminates

Shielding should be used to protect the rubber from exposure to hot metal, petroleum base fluids, acids, etc. Please consult Firestone Industrial Products if you wish to know how the spring will withstand a specific contaminate. (For liquids such as acids, it is important to know both concentration and temperature.)

Storage

The best storage environment is a dark, dry area at normal room temperature.

Percent Compression

The general compression range of a Marsh Mellow spring is 15% to 27%, however this value may vary somewhat among springs and applications. Always follow the load ranges and their corresponding compression percentages as shown in the selection guide.

Allowable Stroke

When applying a Marsh Mellow spring, the stroke throughout the range of motion of the machine being isolated must be considered. Delta strain, defined as the ratio of the stroke to the free length, is restricted to less than 7.5%.

Note that a given stroke is typical of vibrating screen types of applications, where the stroke is designed into the system. In other isolation applications, this stroke may not be known. The stroke is typically not excessive in standard isolation applications, but should be considered. Consult Firestone for assistance.

Disturbing Frequency Range

Marsh Mellow springs are suitable for disturbing frequencies in the 800-1200 CPM (13-20Hz) range or medium stroke applications. High frequency, high stroke applications may lead to overheating the Marsh Mellow spring. Low stroke applications, however, are capable of handling higher disturbing frequencies. Please consult Firestone Industrial Products for assistance.

Lateral Stability

The lateral spring rate to load ratio for a Marsh Mellow spring decreases as deflection increases. This is one reason it is important not to exceed the given load capabilities.

Precautions with Marsh Mellow™ Springs

Center of Gravity

A Marsh Mellow™ spring isolation system is inherently soft (easily deflected); therefore, precautions must be taken to insure that the system is stable. First consider the location of the center of gravity (CG). Ideally, Marsh Mellow springs should be located on the same plane (parallel to the ground) as the center of gravity. Where this is not possible, follow this guideline: The distance between the narrowest mounting points should be at least twice the height of the center of gravity.

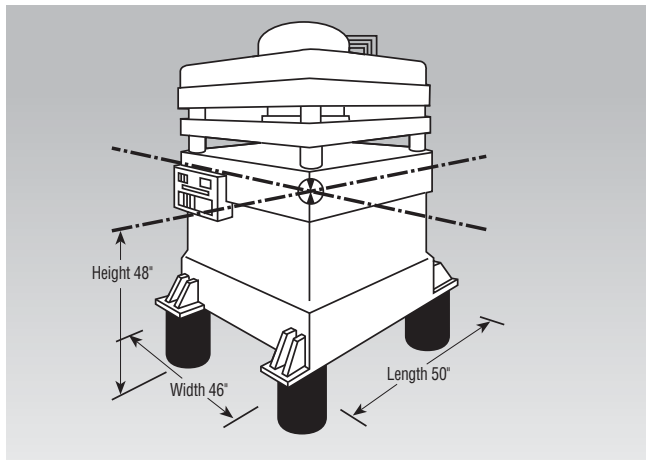

In the above example, the most narrow distance between two Marsh Mellow springs is 46 inches (117 cm). The height to the CG is 48 inches (122 cm); therefore, this system does not meet our guideline. Two possible solutions would be:

1. Increase the base dimensions to meet our guideline by increasing both the width and length to at least 48 x 2 or 96 inches (122 x 2 or 244 cm).
2. Locate the Marsh Mellow Spring at the CG as shown below.

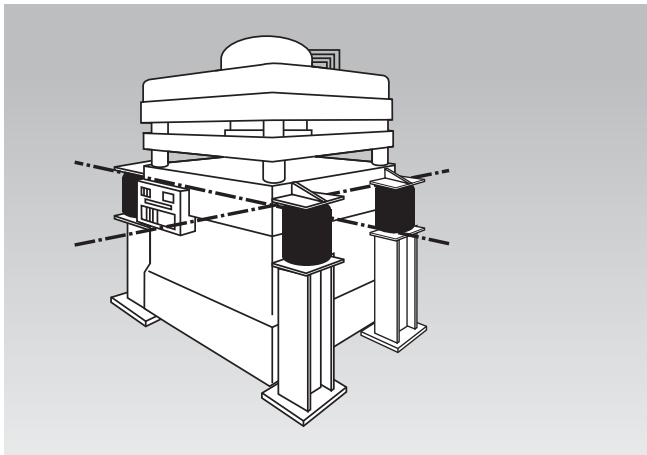

Startup and Shutdown / Resonance and Amplification

Resonance is the condition where the forced frequency of the vibrating system is equal to the natural frequency of the suspension. When this happens, amplification of movement occurs. If the normal stroke of a vibrating screen, for example, is 5/16 of an inch (8 mm), during startup and shutdown (as the machine goes through resonance), the amplitude of movement will be multiplied. So while the machine is accelerating to normal operating speed and decelerating during shutdown, the stroke may be amplified in the range of 1/2 (12 mm) to 1 1/2 (38 mm) inches. The longer the machine takes to go through resonance (to speed up to, or slow down from full operating speed), the larger the amplitude of movement. Note that in some applications, the addition of viscous or friction dampers may be required to reduce the amplitude of motion during startup and shutdown.

Isolating an Unbalanced Mass

The primary concern in this case is the amplitude of movement. It is dependent on:

1. The ratio of the unbalanced moving mass to the total suspended mass.
2. The ratio of the speed of the unbalanced moving mass (forced frequency) to the natural frequency of the Marsh Mellow spring and supported mass system.

The addition of damping to the isolation system ("shock absorbers") will reduce the large amplitude of movement experienced during resonance.

If the amplitude of movement is too great, one possible solution would be to add a static inertia base in order to increase the ratio of the total suspended mass to the moving unbalanced mass. A good "rule of thumb" is 10:1, respectively.

See page 10 for additional information.

Marsh Mellow™ Spring Construction

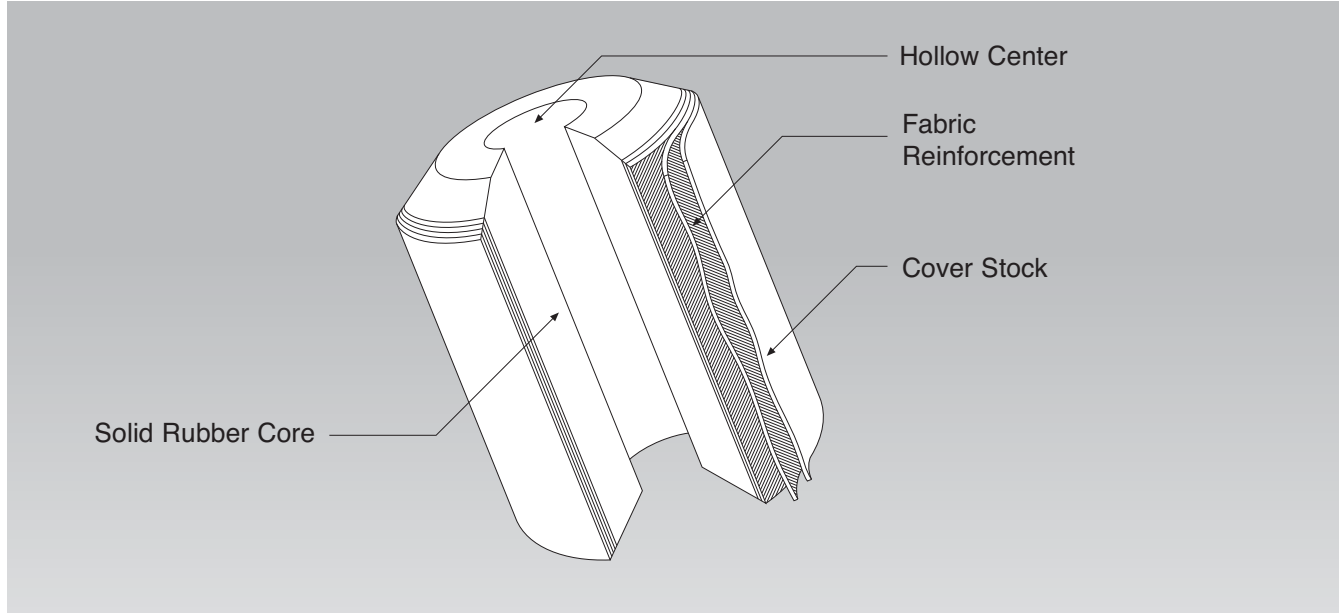

Unique construction elements are the key to the Marsh Mellow™ spring's design flexibility. The basic construction of the Marsh Mellow spring includes a solid rubber core with a hollow center, and several plies of fabric reinforced rubber as an outer cover. These elements may be modified to meet specific load and performance requirements.

Solid Rubber Core Material

The rubber material of the Marsh Mellow spring has a large effect on the performance of the spring as well as to what application it is suited. The rubber material used in vibration isolation applications is efficient and provides little damping. Higher damping compounds are available but better suit shock absorbing applications. The correct rubber core material is application dependent.

Hollow Center

The diameter of the hollow center is another variable in the load capacity of the Marsh Mellow spring. The hollow center directly affects the contact area over which force is applied. As expected, a smaller diameter center will support a greater load compared to an otherwise identical Marsh Mellow spring.

The hollow center also permits mounting the Marsh Mellow spring in a variety of applications. These mounting arrangements are discussed in greater detail within the "Installation and Mounting Arrangements" section of the *Marsh Mellow Spring Design Manual*.

Fabric Reinforcement

The fabric reinforced rubber has a large effect on the performance of the Marsh Mellow springs. In appearance, Marsh Mellow springs are cylindrical in shape with a hollow center the entire length of the part. What separates the Marsh Mellow spring from an all rubber part of the same dimensions is its bias plies of fabric reinforced rubber. The plies, which surround the rubber core material, provide stability and a consistent cylindrical shape. The angle which the plies are laid upon each other may be manipulated to meet application specific requirements.

The performance of the Marsh Mellow spring is influenced by several variables. If the models provided within this catalog do not meet your engineering requirements, please contact Firestone Industrial Products. By modifying the construction details, we may be able to meet your needs.

Cover Stock

The cover rubber aids in abrasion resistance and protects the inner layers of fabric reinforcement. This is not intended to take the place of an adequate design envelope. Please consult data pages for outside diameter dimensions, and allow for adequate space to avoid abrasion.

Marsh Mellow™ Spring Dynamic Characteristics

This section includes terminology associated with the dynamic characteristics of the Marsh Mellow™ spring. The terminology is defined both quantitatively and qualitatively. This information will help in determining which spring best suits an application, whether it is vibration isolation, isolating an unbalanced mass, or shock absorption.

Vibration Isolation

Vibration (disturbing frequency)

The periodic motion of a body, measured in cycles per minute.

Isolator

An isolator is a device which allows two objects to exist without influencing each other. For example, a Marsh Mellow spring prevents a vibrating object from affecting the surrounding environment while still allowing the object to vibrate.

Spring Rate

Spring rate is defined as the amount of force required to deflect a spring 1 inch. Graphically, spring rate is equal to the slope of the load/deflection curve at the corresponding load. A steel coil spring has a constant spring rate as shown by the straight line on the load/deflection chart below. The slope of a Marsh Mellow spring curve changes with height. This results in a changing spring rate. These characteristics are illustrated below:

$$\text{Spring Rate} = \frac{\text{Force}}{\text{Deflection}} = \text{Slope of the Load/Deflection Curve}$$

Load/Deflection Curves

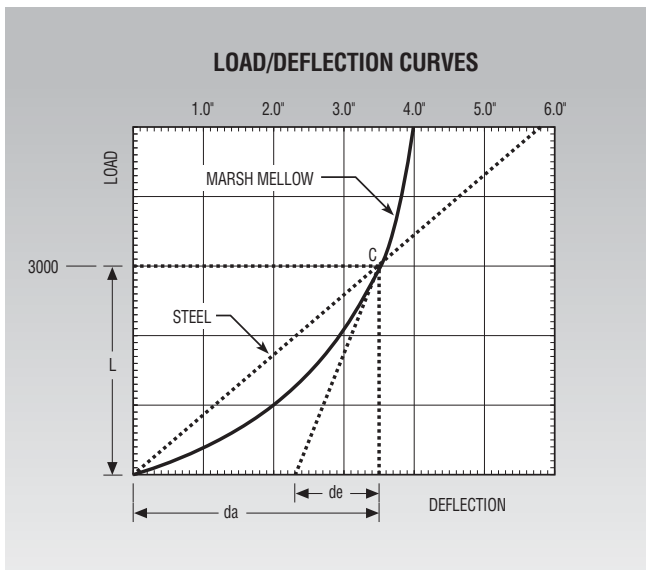

Effective Deflection

Because the slope of the Marsh Mellow spring load/deflection curve changes, the spring rate must be expressed in terms of effective deflection and load. Effective deflection is the difference between actual deflection and the x intercept of the tangent line to the load curve at the design load. Effective deflection is also equal to the given load divided by the slope of the load curve at that point.

$$\text{Effective Deflection (in)} = \frac{\text{Load (lbs)}}{\text{Spring Rate (lbs / in)}}$$

$$\text{Effective Deflection (m)} = \frac{\text{Load (kN)}}{\text{Spring Rate (kN / m)}}$$

Since the spring rate of a coil spring is constant, the effective deflection is equivalent to the actual deflection. A Marsh Mellow spring's spring rate increases as the load increases, therefore the effective deflection is almost constant. This results in a consistent isolator with changing loads.

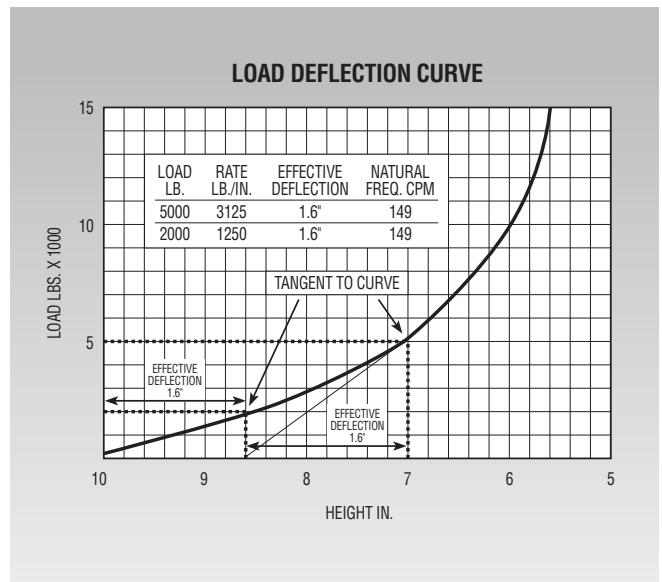

Spring Type	Height	Load	Actual Deflection	Effective Deflection	Spring Rate
Coil Spring	7.3 in	1500lbs	1.2 in	1.2 in	1200 lb/in
Coil Spring	6.0 in	3000lbs	2.5 in	2.5 in	1200 lb/in
Marsh Mellow	6.0 in	1500lbs	2.5 in	1.8 in	810 lb/in
Marsh Mellow	4.8 in	3000lbs	3.7 in	1.8 in	1620 lb/in

Marsh Mellow™ Spring Dynamic Characteristics

Natural Frequency

A spring system's natural frequency determines the efficiency of an isolator. Effective isolators have a low natural frequency.

$$\text{Natural Frequency (CPM)} = 188 \times \sqrt{\frac{\text{Spring Rate (lbs / in)}}{\text{Load (lbs)}}}$$

$$= \frac{188}{\sqrt{\text{Effective Deflection (in)}}}$$

$$\text{Natural Frequency (Hz)} = 0.50 \times \sqrt{\frac{\text{Spring Rate (kN / m)}}{\text{Load (kN)}}}$$

$$= \frac{0.50}{\sqrt{\text{Effective Deflection (m)}}}$$

Disturbing Frequency

Disturbing frequency is the frequency of the motion which needs to be isolated. This is usually expressed in cycles per minute (CPM) or cycles per second (Hz). As an example, the disturbing frequency of a motor is the number of revolutions per minute. The lower the disturbing frequency is, the more difficult it is to isolate.

Transmissibility

Transmissibility is the amount of vibration energy which is transmitted from the vibrating source to the surrounding environment.

$$\% \text{ Transmission} = \frac{100}{\left[\frac{\text{Disturbing Freq (CPM)}}{\text{Natural Freq (CPM)}} \right]^2 - 1}$$

Isolation

Isolation is the amount of vibration energy prevented from being transmitted through the isolator.

$$\% \text{ Isolation} = 100\% - \text{Transmissibility}$$

This equation is illustrated in the chart below.

ISOLATION CHART

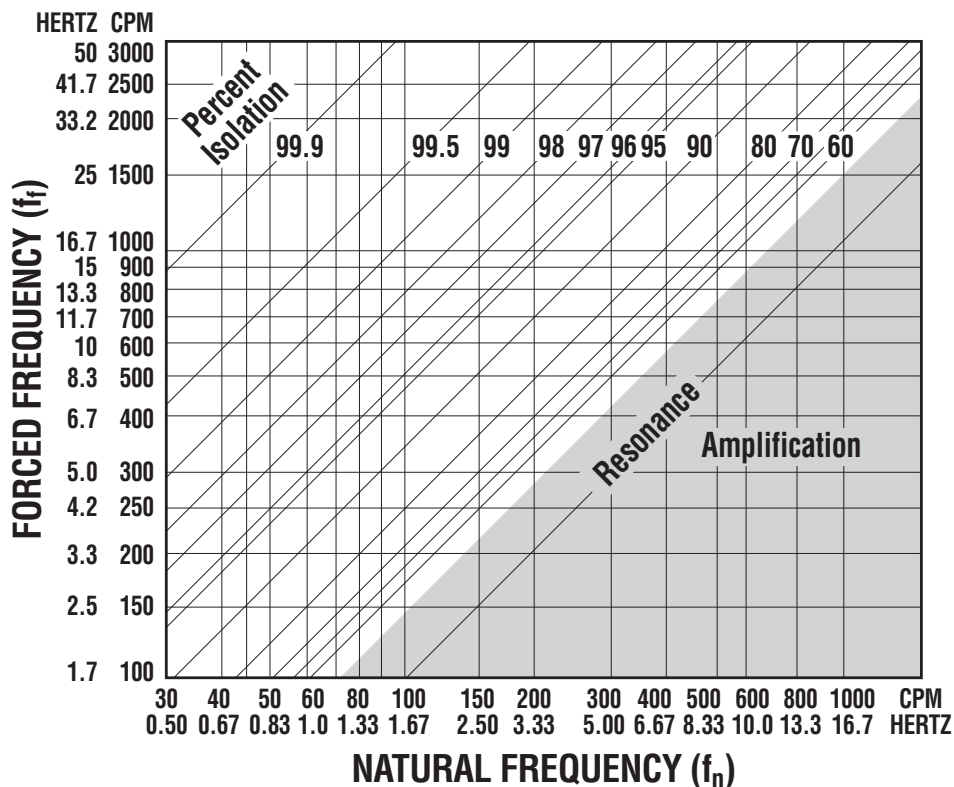

Marsh Mellow™ Spring Dynamic Characteristics

Resonance

Resonance occurs when the disturbing frequency equals the natural frequency of the Marsh Mellow™ spring system. When this occurs the amplitude of vibration will increase without bound. The system is unstable at resonance.

Amplification

Amplification occurs when the disturbing frequency is less than 1.4 times the natural frequency. The vibrating motion is amplified in this range.

Amplitude

Amplitude is the amount of motion associated with the vibration. Quantitatively, the amplitude is half of the total peak to peak distance. On the figure below it is defined as X_1 and X_2 .

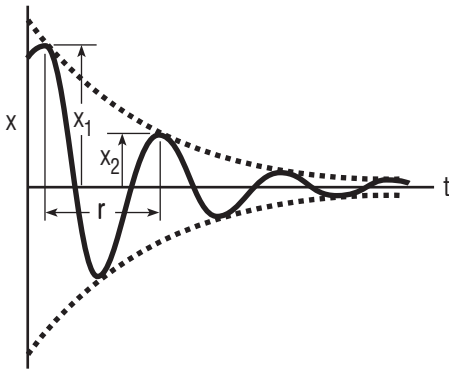

Stroke

The stroke is the total peak to peak distance the machine moves during operation. It is equal to twice the amplitude.

Strain

Marsh Mellow springs will survive a defined amount of movement from vibrating equipment. The amount of movement, or stroke, allowed is measured in delta strain. Delta strain is dependent upon stroke and the free height of the Marsh Mellow spring.

$$\Delta\text{Strain} = \frac{\text{Stroke (in or mm)}}{\text{Free Height (in or mm)}} \times 100\%$$

The maximum delta strain allowed for the Marsh Mellow spring is 7.5%. The following delta chart shows the relationship of free height, stroke, and delta strain.

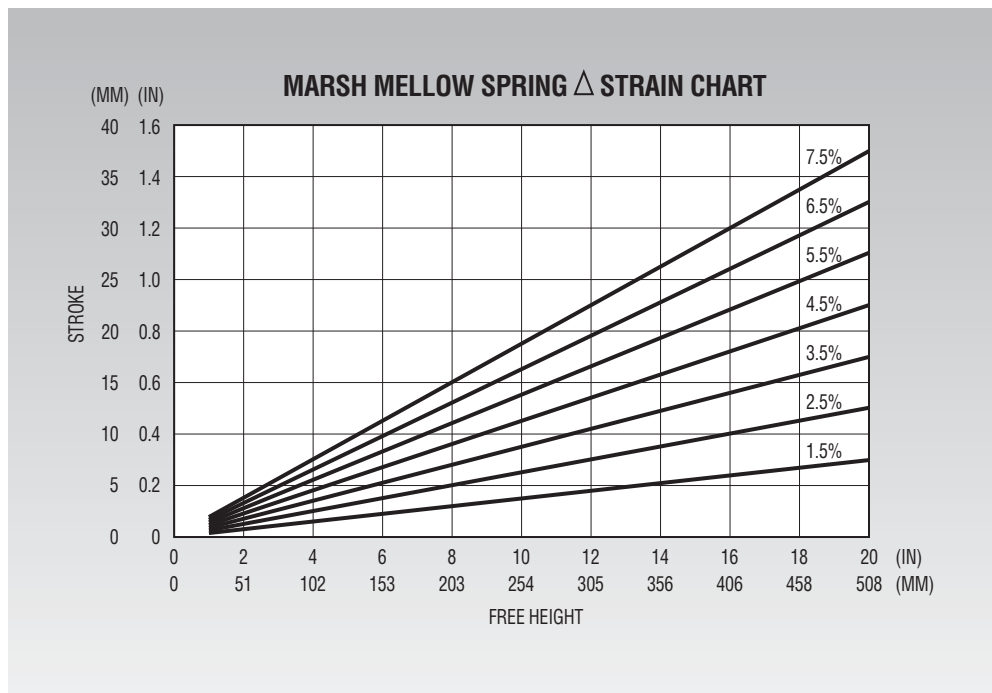

Marsh Mellow™ Spring Dynamic Characteristics

Isolating an Unbalanced Mass

Excursion

Excursion is the amount of movement caused by a moving mass. An isolator will not decrease this movement. Excursion, however, can be controlled through dampers or by increasing the static mass. Excursion is directly proportional to the ratio of moving mass to static mass. The smaller the ratio is, the smaller the amount of excursion. A good “rule of thumb” is a static mass no smaller than 10 times the moving mass.

$$\text{Excursion(in or mm)} \sim \frac{\text{MovingMass(lbs or kN)}}{\text{StaticMass(lbs or kN)}}$$

Static, or Inertia, Mass

Static, or inertia, mass is a heavy base used to decrease the amount of movement caused by a smaller moving mass.

Eccentricity

Eccentricity is the radius a moving mass rotates, thereby causing excursion. The larger the eccentricity, the greater the amount of excursion.

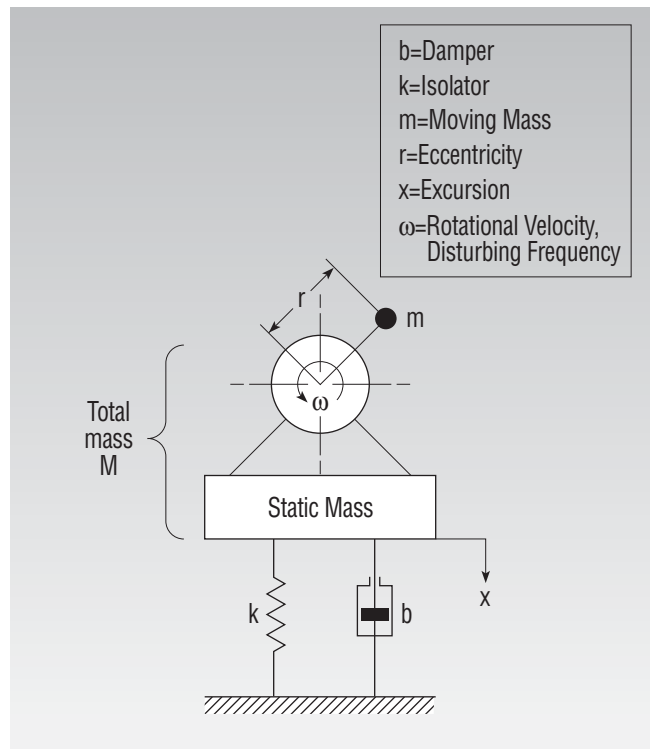

Marsh Mellow™ Spring Dynamic Characteristics

Shock Impact

The Marsh Mellow™ spring is also used in shock impact applications. In these applications, energy must be dissipated from a system. It is important to know both the energy which must be absorbed, as well as the damping capability of the Marsh Mellow spring. The amount of energy in a system can be calculated by knowing the parameter of application (mass of object, velocity, height of free fall, etc.). The energy which can be dissipated into the spring is equal to the amount of hysteresis in the Marsh Mellow spring load/deflection curve. These two variables are required in order to select the correct spring in a shock impact application.

Damping

Damping occurs when energy is dissipated from a system. In order to absorb energy in a system, a damping device is used. Damping is greatest in springs with a large degree of hysteresis. The greater the amount of hysteresis in a Marsh Mellow spring curve, the greater the amount of energy absorbed by the spring and dissipated from the system. Marsh Mellow springs used for vibration isolation are typically low damping.

Hysteresis

Hysteresis can be viewed as the change in load as the spring is compressed and returns to its starting height. A Marsh Mellow spring will produce a greater amount of force as it is compressed compared to the extension. When a solid is deflected, some of the energy necessary to deflect it turns into heat. This is not returned in the form of return force, but as dissipated heat.

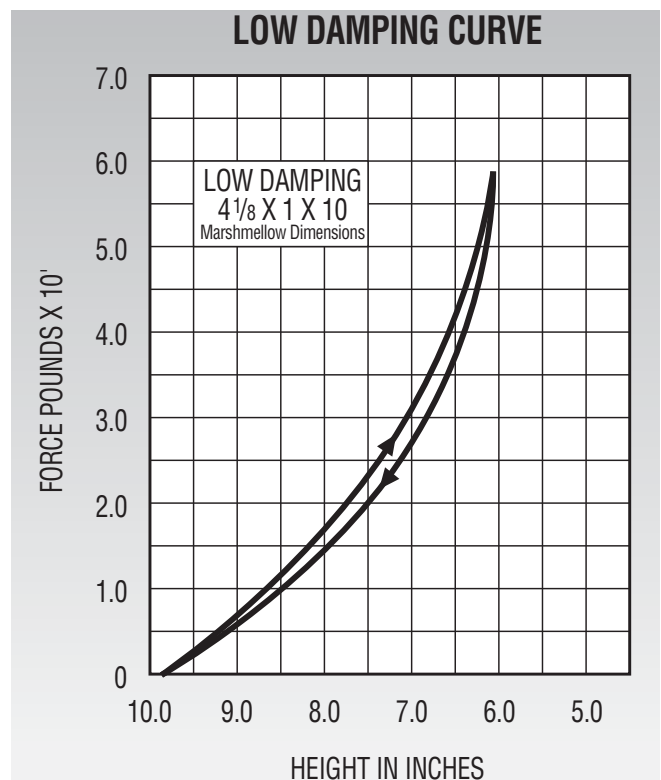
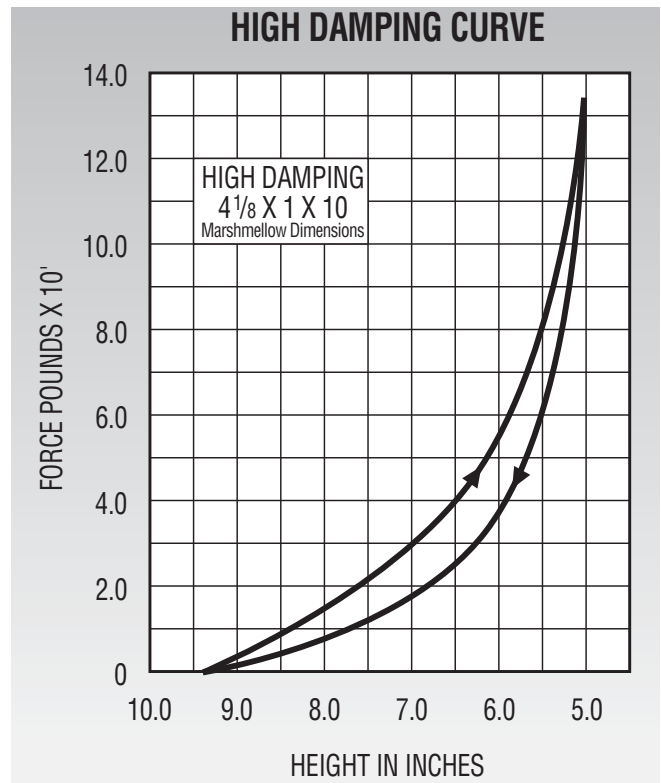

Individual Data Sheet

On each individual data sheet detailed information is provided on a specific Marsh Mellow™ spring. Each sheet contains four main components.

- Part Number
- Table of Dynamic Characteristics
- Drawing showing Marsh Mellow spring Dimensions and Mounting Pin Dimensions
- Load/Deflection Curve

Part Number

The part number of the Marsh Mellow spring is shown at the top of the data sheet. The part number will start with W22-358-__ __ __. The last four digits are specific for each Marsh Mellow spring.

Table of Dynamic Characteristics

The Table of Dynamic Characteristics contains critical information needed to select the correct Marsh Mellow spring. The range of allowable percentages of compression are given at the top of the table. The corresponding heights and loads, as well as the spring rate and effective deflection, are listed below the percentages of compression. It is necessary to know the natural frequency of the Marsh Mellow spring to determine the percentage of isolation. The outside diameter of the Marsh Mellow spring throughout the allowable compression is listed in order to check the design envelope.

(W22-358-0176)

IMPERIAL					
Compression (%)	15.0	20.0	22.5	25.0	27.5
Load (lbs.)	2300	3350	4000	4600	5300
Height (in.)	8.5	8.0	7.8	7.5	7.3
Rate (lbs./in.)	2000	2400	2500	2600	3100
Effective Deflection (in.)	1.15	1.40	1.60	1.77	1.71
Natural Freq. (CPM)	175	159	149	141	144
Maximum OD (in.)	7.9	8.1	8.3	8.4	8.6

Marsh Mellow Spring and Mounting Pin Dimensions

A Marsh Mellow spring has three important dimensions: outside diameter, inside diameter, and free height. The three dimensions illustrated on the data sheet are at an unloaded state. The heights and outside diameters of the Marsh Mellow spring under loaded conditions are listed in the table of dynamic characteristics.

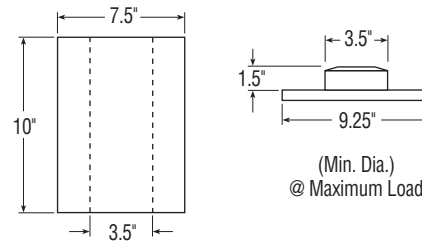

The mounting pin dimensions for the specific spring are needed for installation. These given dimensions are for typically mounting the Marsh Mellow spring in vibration isolation applications. The height of the mounting pin, and mounting plate diameter, are the minimum values allowed at maximum loading. The pin diameter should be equal to the inside diameter of the spring.

Individual Data Sheet

Load/Deflection Curve

The load/deflection curve shows the load vs. height of the Marsh Mellow™ spring.

In order to determine the height of the Marsh Mellow spring at a given load, use the load/deflection curve. Move horizontally on the chart from the given load on the vertical axis. Stop and make a fixed point at the compression curve. The height directly below this point on the x axis is the height of the Marsh Mellow spring at the given load. This procedure is shown on the chart below with a given load of 4000 lbs.

1. Proceed right horizontally from a load of 4000 lbs.
2. Stop and make a fixed point directly on the compression curve.
3. Proceed straight down to the horizontal axis.
4. The intersection at the horizontal axis is the height at the given load, 7.8 inches.

LOAD/DEFLECTION CURVE

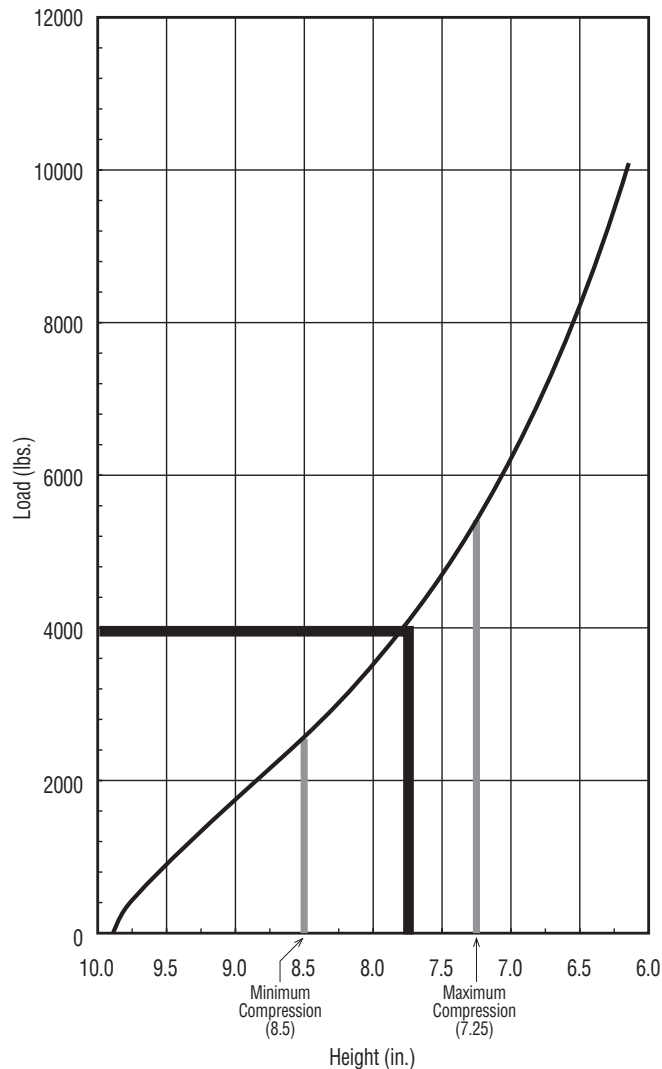

Selection Procedure *(Imperial)*

Vibration Isolation Selection

1. For specific design parameters needed to determine the correct Marsh Mellow™ spring for an application, consult the “Design Parameter Sheet” on page 61.
2. If possible, determine the load at each mounting point. If this is not possible, estimate the load on the Marsh Mellow spring by adding the weight of the machine plus the weight of the materials on the machine while operating, then divide the total weight by the number of Marsh Mellow springs to be used. This estimate will only be accurate if the load’s center of gravity is equidistant from each mounting point. If the weight of the machine is unknown, contact the equipment manufacturer, your distributor or Firestone Industrial Products for assistance. Firestone Industrial Products’ or your distributor’s machine weight estimates are based on the manufacturer’s published weights of current models of the same size and type. Weight consideration must be given to a special machine, modified machines, or older machines that will add weight to the unit.
3. Select a spring that falls in the mid-range of the minimum and maximum load capacities shown in the “Selection Guide”. For maximum life and stability, it is suggested that Marsh Mellow springs be used at or less than 25% (of free height) actual static deflection. Although the maximum loading figures in the above selection guide are given at 27.5% deflection (and these Marsh Mellow springs all pass our lateral stability test at up to 30% deflection), the lateral rate to load ratio decreases as deflection increases. The extra 2.5% deflection, then, is a safety factor for possible weight miscalculations. Additionally, the delta strain ($\text{Stroke/Free Length} \times 100$) should not exceed 7.5%.
4. If more than one spring meets the load criteria in number 2, then select the spring with the lowest natural frequency (isolation percentage will be increased).
5. Determine the stroke required.
6. Refer to the second selection guide table. Check to make sure that for a given stroke and part, the height and load are within the allowable limits given.
7. If it does not fall within the proper range, then select a different spring or go to more than one Marsh Mellow spring per corner.
8. Consult the individual data page for the specific load and vibration capabilities, as well as mounting and Marsh Mellow spring dimensions.
9. Determine if the natural frequency of the Marsh Mellow spring will sufficiently isolate the disturbing vibration.
10. Tag lines are usually required for inclined screens or screens with off-mounted pivoted motors. (Consider using our tension band W22-358-0215 or W22-358-0275).
11. Please review the “Installation” section of the *Marsh Mellow Spring Design Manual* for additional information.

Selection Procedure *(Imperial)*

Vibration Isolation Selection Example

The following example follows the correct procedure in determining which Marsh Mellow™ spring best suits a given set of requirements.

The vibrating screen illustrated to the right has the following description and design requirements:

Description of Equipment	= Vibrating screen
Total Weight of Machine	= 12000 lbs.
Total Material Load	= 4000 lbs.
Number of Mounting Points	= 4
Space Available	= 10 inch diameter footprint
Stroke	= 1/2 inch
Disturbing Frequency	= 1000CPM
Percent Isolation Desired	= 90%

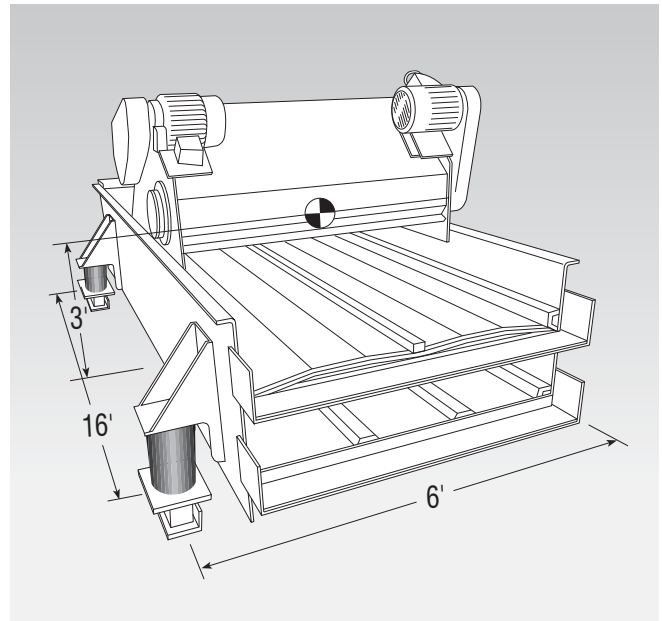

1. Determine Individual Spring Load

The exact load at each mounting point is not available, so the individual loads must be estimated. The minimum load each spring will support is assumed to be equal to the machine weight divided by the number of mounting points.

$$\text{Minimum Load} = \frac{\text{Machine Load (lbs)}}{\# \text{ of Mounting Points}} = \frac{12000 \text{ lbs}}{4} = 3000 \text{ lbs per spring}$$

The maximum load is equal to the machine load plus the weight of the material.

$$\text{Maximum Load} = \frac{(\text{Machine} + \text{Material Load}) \text{ lbs}}{\# \text{ of Mounting Points}} = \frac{(12000 + 4000) \text{ lbs}}{4} = 4000 \text{ lbs per spring}$$

2. Examine Marsh Mellow Spring Load Capabilities

From the "Selection Guide - Load Capabilities", seven different Marsh Mellow springs will support load range from 3000lbs. to 4000lbs. The W22-358-0200, 0176, 0042, 0190, 0179, 0122, and 0228. As discussed in the "Dynamic Characteristics" section, a lower natural frequency Marsh Mellow spring will provide better isolation. Since the W22-358-0176 has a low natural frequency at both minimum and maximum loading, we will select this part for the example.

3. Determine Stroke Requirement

The required stroke for this screen is 0.5 inches with a maximum load of 4000lbs. On the "Selection Table - Stroke Requirements", the 0176 has a maximum stroke capability of 0.5 inches with a load range of 1940 to 4540lbs. The 0176 meets this requirement.

Selection Procedure *(Imperial)*

4. Determine Exact % Isolation

The percentage of isolation can either be calculated or the % Isolation chart may be used. The first step is to refer to the individual data page for necessary information. The Dynamic Characteristics table will provide this data.

IMPERIAL					
Compression (%)	15.0	20.0	22.5	25.0	27.5
Load (lbs.)	2300	3350	4000	4600	5300
Height (in.)	8.5	8.0	7.8	7.5	7.3
Rate (lbs./in.)	2000	2400	2500	2600	3100
Effective Deflection (in.)	1.15	1.40	1.60	1.77	1.71
Natural Freq. (CPM)	175	159	149	141	144
Maximum OD (in.)	7.9	8.1	8.3	8.4	8.6

At the minimum load of 3000lbs, the 0176 is between 15% and 20% compression. We can interpolate this data and estimate the natural frequency at minimum load.

$$\frac{\text{MinimumLoad} - \text{Load@15\%}}{\text{Load@20\%} - \text{Load@15\%}} = \frac{\text{NaturalFreq} - \text{NaturalFreq@15\%}}{\text{NaturalFreq@20\%} - \text{NaturalFreq@15\%}}$$

$$\text{NaturalFreq} = \text{NatFreq@15\%} + \frac{[(\text{MinimumLoad} - \text{Load@15\%}) \times (\text{NatFreq@20\%} - \text{NatFreq@15\%})]}{\text{Load@20\%} - \text{Load@15\%}}$$

$$\text{NaturalFreq} = 175\text{CPM} + \frac{[(3000 - 2300)\text{lbs} \times (159 - 175)\text{CPM}]}{(3350 - 2300)\text{lbs}}$$

$$\text{NaturalFreq@3000lbs} = 164\text{CPM}$$

We can interpolate the natural frequency at the maximum load of 4000lbs in a similar way. However, in this case we know the natural frequency at 4000lbs directly from the data table.

$$\text{NaturalFreq@4000lbs} = 149\text{CPM}$$

Knowing these natural frequencies, as well as the disturbing frequency, allows us to determine the exact % isolation with the following equations:

$$\% \text{Isolation} = 100 - \left[\frac{100}{\left(\frac{\text{DisturbingFreq}^2}{\text{NaturalFreq}^2} \right) - 1} \right]$$

$$\% \text{Isolation@3000lbs} = 100 - \left[\frac{100}{\left(\frac{1000\text{CPM}^2}{164\text{CPM}^2} \right) - 1} \right]$$

$$\% \text{Isolation@3000lbs} = 97.2\%$$

$$\% \text{Isolation@4000lbs} = 100 - \left[\frac{100}{\left(\frac{1000\text{CPM}^2}{149\text{CPM}^2} \right) - 1} \right]$$

$$\% \text{Isolation@4000lbs} = 97.7\%$$

(Note: The percentage of isolation is relatively constant with changing loads.)

Selection Procedure *(Imperial)*

PERCENT ISOLATION CHART

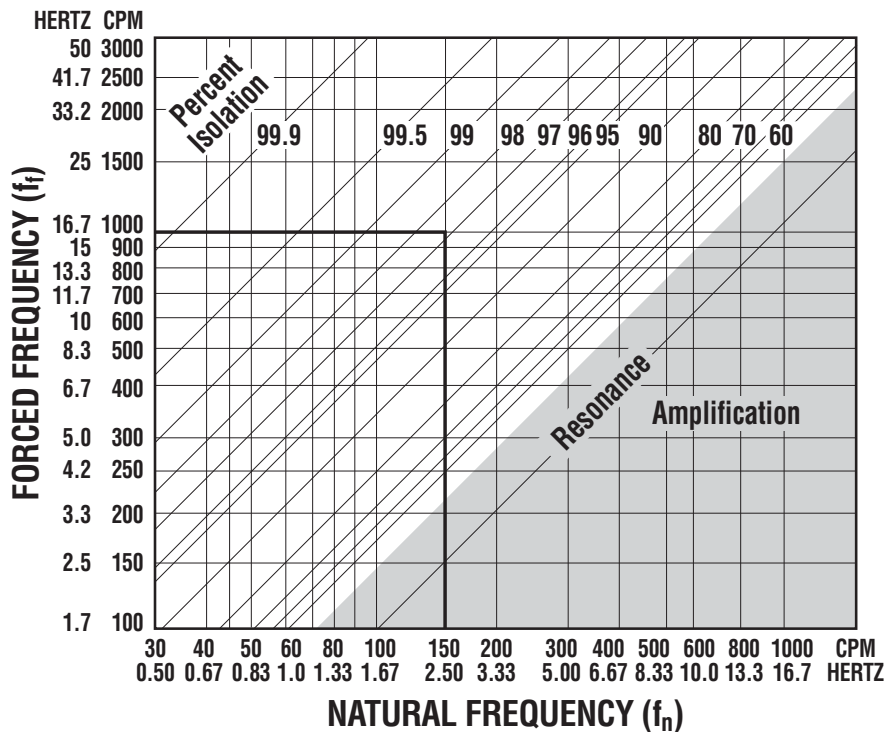

The percentage of isolation can also be determined using the % isolation chart shown above.

The diagonal lines across the chart represent specific isolation percentages. The intersection point, where the forced frequency and natural frequency meet, will lie on or between these diagonal lines. As shown above, the forced frequency of 1000 CPM and the natural frequencies of 149 and 164 CPM result in 97-98% isolation.

The percent isolation of 97% exceeds the required isolation of 90%.

5. Determine Exact Strain

The maximum allowable delta strain a Marsh Mellow™ spring can withstand is 7.5%. In order to calculate this we need to know the free height of the Marsh Mellow spring. Strain is equal to the stroke, 0.5 inches, divided by the free height.

$$\Delta\text{Strain} = \frac{\text{Stroke (in)}}{\text{FreeHeight (in)}} \times 100\%$$

$$\Delta\text{Strain} = \frac{0.5 \text{ inches}}{10 \text{ inches}} \times 100\% = 5\%$$

The required stroke is within the 0176's limitations.

6. Design Envelope Requirements

The Dynamic Characteristics Table shows that the outside diameter meets the space requirements of a minimum 10 inch diameter footprint. The OD is given at various heights between 15% and 27.5% compression. The OD of the Marsh Mellow spring at 26% compression is approximately 8.5 inches. The height of the Marsh Mellow spring can easily be read from the load deflection curve. From the previous section "Individual Data Sheet, Load Deflection Curve" we determined the height of the 0176 with a load of 4000 lbs is 7.8 inches.

7. Lateral Stability

As shown on the sketch of the equipment, the Marsh Mellow springs are mounted within the recommended distance of the center of gravity. The 0176 is also being used between 15% and 27.5% compression for maximum lateral stability. For additional stability with inclined screens or screen with off-mounted pivot motors, Firestone tension bands are often used as tag lines. The W22-358-0215 and 0275 tension bands are widely used in this application.

Selection Procedure *(Imperial)*

Shock Impact Selection

Marsh Mellow™ springs are commonly found on overhead cranes and other bumper applications. The following are the basic guidelines in determining the correct Marsh Mellow spring under shock impact conditions.

Calculating the Required Energy Dissipation

To size the proper Marsh Mellow spring, the amount of energy generated by the moving object must be known.

There are several ways to calculate this.

*For a free falling mass **without** an initial velocity:*

The following will calculate the amount of energy that needs to be absorbed for a free falling mass which starts at rest.

Potential Energy = mass x gravity x height (lb_{force}•inches)

mass x gravity = the weight of the object (lb_{force})

height = the height the object begins its descent (inches)

*For a free falling mass **with** an initial velocity:*

This calculation models a falling mass which has an initial velocity. The energy generated during free fall must be added to the kinetic energy associated with its initial velocity.

Kinetic Energy = $1/2 \times \text{mass} \times \text{velocity}^2$ (lb_{force}•inches)

Potential Energy = see calculation for free falling mass without initial velocity

mass = $\frac{\text{weight (lb}_{\text{force}})}{386}$

velocity = initial velocity before free fall
 $\left(\frac{\text{inches}}{\text{seconds}} \right)$

For a horizontal impact or if the velocity immediately before impact is known:

Under these conditions the kinetic energy generated by velocity must be calculated.

Kinetic Energy = $1/2 \times \text{mass} \times \text{velocity}^2$ (lb_{force}•inches)

mass = $\frac{\text{weight (lb}_{\text{force}})}{386}$

velocity = velocity object $\left(\frac{\text{inches}}{\text{second}} \right)$

Marsh Mellow Spring Selection

After the amount of energy needed to be absorbed is calculated, the proper Marsh Mellow spring for the application may be determined. Please contact Firestone Industrial Products to select the correct Marsh Mellow spring which has at least the same amount of absorbed energy capability as required for the application.

Note: While the Marsh Mellow spring will absorb the impact energy on the compression stroke and dissipate some amount of this energy, it will still return some of the energy in the form of a rebound stroke. In some applications, viscous or friction dampers may be required to control the speed of the rebound stroke.

Selection Procedure (*Metric*)

Vibration Isolation Selection

1. For specific design parameters needed to determine the correct Marsh Mellow™ spring for an application, consult the “Design Parameter Sheet” on page 61.
2. If possible, determine the load at each mounting point. If this is not possible, estimate the load on the Marsh Mellow spring by adding the weight of the machine plus the weight of the materials on the machine while operating, then divide the total weight by the number of Marsh Mellow springs to be used. This estimate will only be accurate if the load’s center of gravity is equidistant from each mounting point. If the weight of the machine is unknown, contact the equipment manufacturer, your distributor or Firestone for assistance. Firestone’s or your distributor’s machine weight estimates are based on the manufacturer’s published weights of current models of the same size and type. Weight consideration must be given to a special machine, modified machines, or older machines that will add weight to the unit.
3. Select a spring that falls in the mid-range of the minimum and maximum load capacities shown in the “Selection Guide”. For maximum life and stability, it is suggested that Marsh Mellow springs be used at or less than 25% (of free height) actual static deflection. Although the maximum loading figures in the above selection guide are given at 27.5% deflection (and these Marsh Mellow springs all pass our lateral stability test at up to 30% deflection), the lateral rate to load ratio decreases as deflection increases. The extra 2.5% deflection, then, is a safety factor for possible weight miscalculations. Additionally, the delta strain (Stroke/Free Length x 100) should not exceed 7.5%.
4. If more than one spring meets the load criteria in number 2, then select the spring with the lowest natural frequency (isolation percentage will be increased).
5. Determine the stroke required.
6. Refer to the second selection guide table. Check to make sure that for a given stroke and part, the height and load are within the allowable limits given.
7. If it does not fall within the proper range, then select a different spring or go to more than one Marsh Mellow spring per corner.
8. Consult the individual data page for the specific load and vibration capabilities, as well as mounting and Marsh Mellow spring dimensions.
9. Determine if the natural frequency of the Marsh Mellow spring will sufficiently isolate the disturbing vibration.
10. Tag lines are usually required for inclined screens or screens with off-mounted pivoted motors. (Consider using our tension band W22-358-0215 or W22-358-0275).
11. Please review the “Installation” section of the *Marsh Mellow Spring Design Manual* for additional information.

Selection Procedure (Metric)

Vibration Isolation Selection Example

The following example follows the correct procedure in determining which Marsh Mellow™ spring best suits a given set of requirements.

The vibrating screen illustrated to the right has the following description and design requirements:

Description of Equipment	= Vibrating screen
Total Weight of Machine	= 53.3kN
Total Material Load	= 17.8kN
Number of Mounting Points	= 4
Space Available	=254mm diameter footprint
Stroke	= 12mm
Disturbing Frequency	= 16.7Hz
Percent Isolation Desired	= 90%

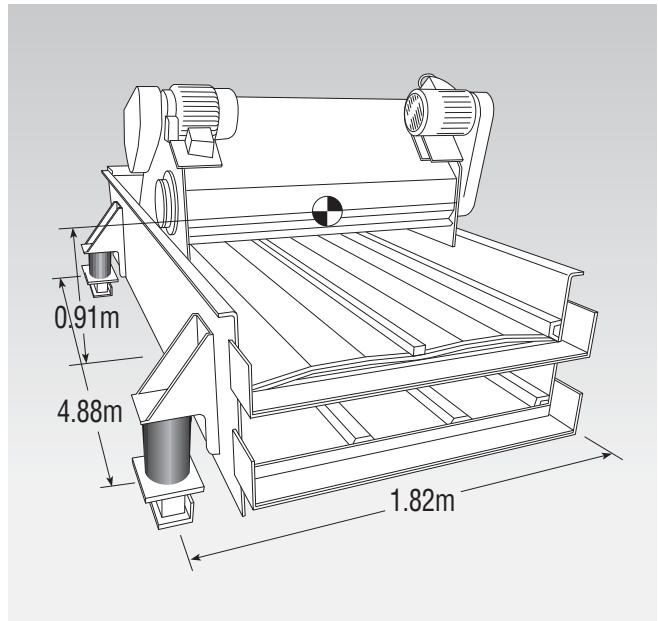

1. Determine Individual Spring Load

The exact load at each mounting point is not available, so the individual loads must be estimated. The minimum load each spring will support is assumed to be equal to the machine weight divided by the number of mounting points.

$$\text{Minimum Load} = \frac{\text{Machine Load(kN)}}{\# \text{ of Mounting Points}} = \frac{53.3\text{kN}}{4} = 13.3\text{kN per spring}$$

The maximum load is equal to the machine load plus the weight of the material.

$$\text{Maximum Load} = \frac{(\text{Machine} + \text{Material Load})\text{kN}}{\# \text{ of Mounting Points}} = \frac{(53.3 + 17.8)\text{kN}}{4} = 17.8\text{kN per spring}$$

2. Examine Marsh Mellow Spring Load Capabilities

From the "Selection Guide - Load Capabilities", seven different Marsh Mellow springs will support load range from 13.3kN to 17.8kN. The W22-358-0200, 0176, 0042, 0190, 0179, 0122, and 0228. As discussed in the "Dynamic Characteristics" section, a lower natural frequency Marsh Mellow spring will provide better isolation. Since the W22-358-0176 has a low natural frequency at both minimum and maximum loading, we will select this part for the example.

3. Determine Stroke Requirement

The required stroke for this screen is 12mm with a maximum load of 17.8kN. On the "Selection Table - Stroke Requirements", the 0176 has a maximum stroke capability of 12mm with a load range of 8.62 to 20.18kN. The 0176 meets this requirement.

Selection Procedure (Metric)

4. Determine Exact % Isolation

The percentage of isolation can either be calculated or the % Isolation chart may be used. The first step is to refer to the individual data page for necessary information. The Dynamic Characteristics table will provide this data.

M E T R I C					
Compression (%)	15.0	20.0	22.5	25.0	27.5
Load (kN)	10.22	14.89	17.78	20.44	23.56
Height (mm)	216	203	197	191	184
Rate (kN/m)	350	420	437	455	542
Effective Deflection (mm)	29	35	41	45	43
Natural Freq. (Hz)	2.92	2.65	2.48	2.36	2.40
Maximum OD (mm)	201	206	211	213	218

At the minimum load of 13.3kN, the 0176 is between 15% and 20% compression. We can interpolate this data and estimate the natural frequency at minimum load.

$$\frac{\text{MinimumLoad} - \text{Load@15\%}}{\text{Load@20\%} - \text{Load@15\%}} = \frac{\text{NaturalFreq} - \text{NaturalFreq@15\%}}{\text{NaturalFreq@20\%} - \text{NaturalFreq@15\%}}$$

$$\text{NaturalFreq} = \text{NatFreq@15\%} + \frac{[(\text{MinimumLoad} - \text{Load@15\%}) \times (\text{NatFreq@20\%} - \text{NatFreq@15\%})]}{\text{Load@20\%} - \text{Load@15\%}}$$

$$\text{NaturalFreq} = 2.92\text{Hz} + \frac{[(13.3 - 10.22)\text{kN} \times (2.65 - 2.92)\text{Hz}]}{(14.89 - 10.22)\text{Hz}}$$

$$\text{NaturalFreq@13.3kN} = 2.73\text{Hz}$$

We can interpolate the natural frequency at the maximum load of 17.8kN in a similar way. However, in this case we know the natural frequency at 17.8kN directly from the data table.

$$\text{NaturalFreq@17.8kN} = 2.48\text{Hz}$$

Knowing these natural frequencies, as well as the disturbing frequency, allows us to determine the exact % isolation with the following equations:

$$\% \text{Isolation} = 100 - \left[\frac{100}{\left(\frac{\text{DisturbingFreq}^2}{\text{NaturalFreq}} \right)^{-1}} \right]$$

$$\% \text{Isolation@13.3kN} = 100 - \left[\frac{100}{\left(\frac{16.7\text{Hz}^2}{2.73\text{Hz}} \right)^{-1}} \right]$$

$$\% \text{Isolation@13.3kN} = 97.2\%$$

$$\% \text{Isolation@17.8kN} = 100 - \left[\frac{100}{\left(\frac{16.7\text{Hz}^2}{2.48\text{Hz}} \right)^{-1}} \right]$$

$$\% \text{Isolation@17.8kN} = 97.7\%$$

(Note: The percentage of isolation is relatively constant with changing loads.)

Selection Procedure (Metric)

PERCENT ISOLATION CHART

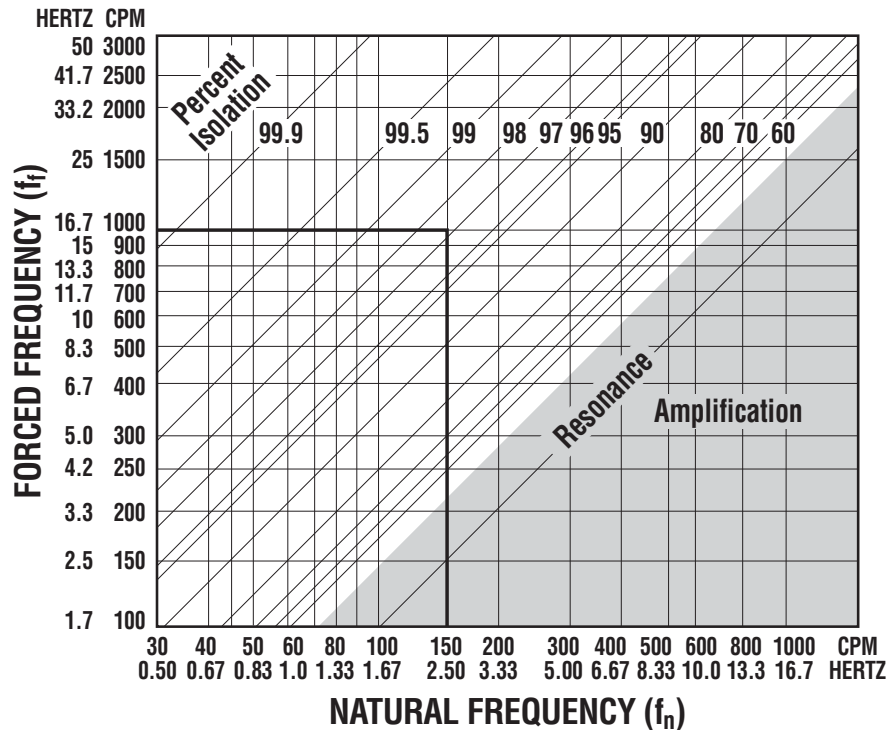

The percentage of isolation can also be determined using the % isolation chart shown above.

The diagonal lines across the chart represent specific isolation percentages. The intersection point, where the forced frequency and natural frequency meet, will lie on or between these diagonal lines. As shown above the forced frequency of 16.7Hz and the natural frequencies of 2.48 and 2.73Hz result in 97-98% isolation.

The percent isolation of 97% exceeds the required isolation of 90%.

5. Determine Exact Strain

The maximum allowable delta strain a Marsh Mellow™ spring can withstand is 7.5%. In order to calculate this we need to know the free height of the Marsh Mellow spring. Strain is equal to the stroke, 12mm, divided by the free height.

$$\Delta\text{Strain} = \frac{\text{Stoke (mm)}}{\text{FreeHeight (mm)}} \times 100\%$$

$$\Delta\text{Strain} = \frac{12\text{mm}}{254\text{mm}} \times 100\% = 5\%$$

The required stroke is within the 0176's limitations.

6. Design Envelope Requirements

The Dynamic Characteristics table shows that the outside diameter meets the space requirements of a minimum 254mm diameter footprint. The OD is given at various heights between 15% and 27.5% compression. The OD of the Marsh Mellow spring at 26% compression is approximately 216mm. The height of the Marsh Mellow spring can easily be read from the load deflection curve. From the previous section "Individual Data Sheet, Load Deflection Curve", we determined the height of the 0176 with a load of 17.8kN is 198mm.

7. Lateral Stability

As shown on the sketch of the equipment, the Marsh Mellow springs are mounted within the recommended distance of the center of gravity. The 0176 is also being used between 15% and 27.5% compression for maximum lateral stability. For additional stability with inclined screens or screen with off-mounted pivot motors, Firestone tension bands are often used as tag lines. The W22-358-0215 and 0275 tension bands are widely used in this application.

Selection Procedure (*Metric*)

Shock Impact Selection

Marsh Mellow™ springs are commonly found on overhead cranes and other bumper applications. The following are the basic guidelines in determining the correct Marsh Mellow spring under shock impact conditions.

Calculating the Required Energy Dissipation

To size the proper Marsh Mellow spring, the amount of energy generated by the moving object must be known.

There are several ways to calculate this.

*For a free falling mass **without** an initial velocity:*

The following will calculate the amount of energy that needs to be absorbed for a free falling mass which starts at rest.

Potential Energy = mass x gravity x height (N•m)

mass x gravity = the weight of the object (N)

height = the height the object begins its descent (m)

*For a free falling mass **with** an initial velocity:*

This calculation models a falling mass which has an initial velocity. The energy generated during free fall must be added to the kinetic energy associated with its initial velocity.

Kinetic Energy = $1/2 \times \text{mass} \times \text{velocity}^2$ (N•m)

Potential Energy = see calculation for free falling mass without initial velocity

mass = $\frac{\text{weight (N)}}{9.81}$

velocity = initial velocity before free fall
 $\left(\frac{\text{meters}}{\text{second}} \right)$

For a horizontal impact or if the velocity immediately before impact is known:

Under these conditions the kinetic energy generated by velocity must be calculated.

Kinetic Energy = $1/2 \times \text{mass} \times \text{velocity}^2$ (N•m)

mass = $\frac{\text{weight (N)}}{9.81}$

velocity = velocity object $\left(\frac{\text{meters}}{\text{second}} \right)$

Marsh Mellow Spring Selection

After the amount of energy needed to be absorbed is calculated, the proper Marsh Mellow spring for the application may be determined. Please contact Firestone Industrial Products to select the correct Marsh Mellow spring which has at least the same amount of absorbed energy capability as required for the application.

Note: While the Marsh Mellow springs will absorb the impact energy on the compression stroke and dissipate some amount of this energy, it will still return some of the energy in the form of a rebound stroke. In some applications, viscous or friction dampers may be required to control the speed of the rebound stroke.

Installation

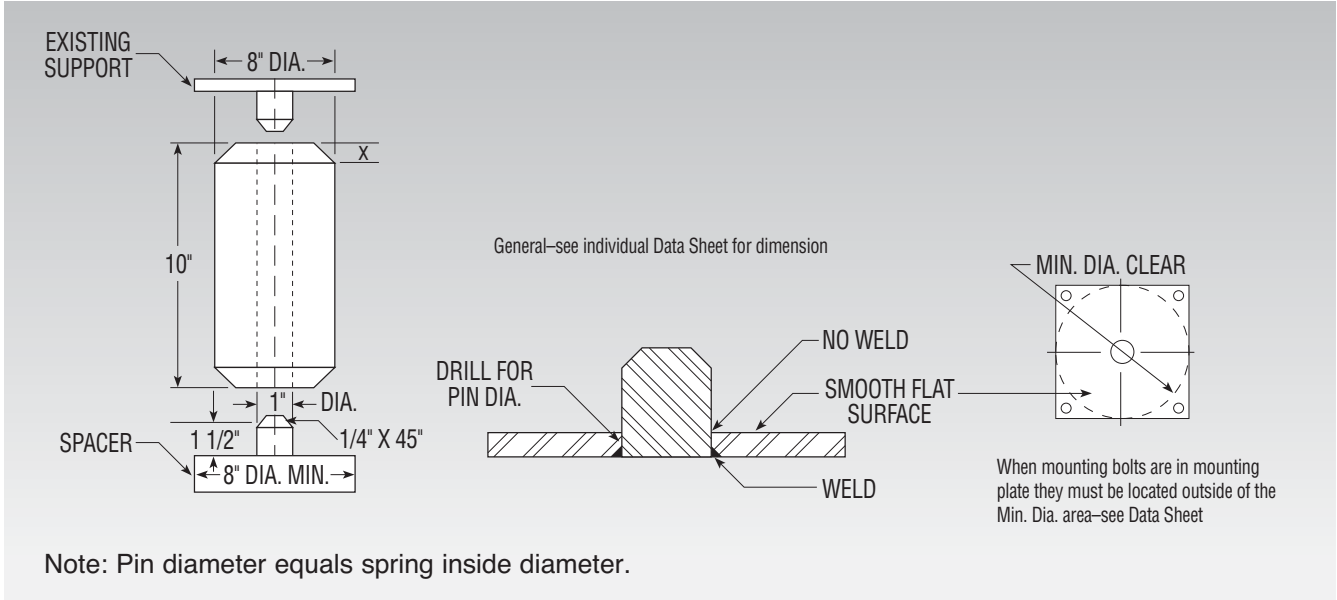

Vibration Isolation New Installation

1. Select the correct Marsh Mellow™ spring for the specific application following the guide lines in “Selection Procedure” of the *Marsh Mellow Spring Design Manual*.
 2. Fabricate mounting plates with locating pins for the Marsh Mellow spring according to the dimensions on the individual data sheet.
 3. Raise the machine to a height greater than the height of the mounting plates and Marsh Mellow spring free height. Prepare the mounting surface,* and insert the Marsh Mellow spring assembly with upper and lower mounting plates in place.
 4. Carefully lower the machine on mounting plates, making sure the upper and lower mounting plates are in line vertically at all support points.
 5. **Caution**—check the loaded Marsh Mellow spring height. It **must** be within the height range shown on the data sheet. If the height is not within the height range, the estimated loads are not correct. If the height is greater than the limit, the machine may shift while going through resonance. If the height is less than allowable, the spring is overloaded and may be damaged while running. In either case, contact your distributor or Firestone Industrial Products. Record the actual height to determine the actual load from the data sheet. This will assist your distributor or Firestone in recommending another size Marsh Mellow spring.
 6. If the height of the loaded Marsh Mellow spring is within the range but the machine is not level, raise the lower end by using shims.
 7. If the height is correct, drill holes in the mounting plates and mating machine mount and floor mount. Bolt securely.
 8. Run the machine through startup and shutdown 2 or 3 times to observe any erratic motion. If gallop through resonance is excessive, something may be wrong. If there is any question, contact your distributor or Firestone Industrial Products.
 9. Operate the machine as you would normally—check the temperature of the Marsh Mellow spring after about 1 hour and 4 hours of operation by placing your hand on the surface of the Marsh Mellow spring. The Marsh Mellow spring will be warm. If the Marsh Mellow spring is so hot that you can't leave your hand on it, something is wrong. Check your spring height. If it is not within the height range as shown on the Marsh Mellow spring data sheet, your load is not correct and a different size spring is needed. Contact your distributor or Firestone and **do not** continue to run the machine under this condition.
- *Note: Use water or silicone spray lube to assist in pressing the Marsh Mellow spring on the pin. Avoid damaging the ID.

Installation

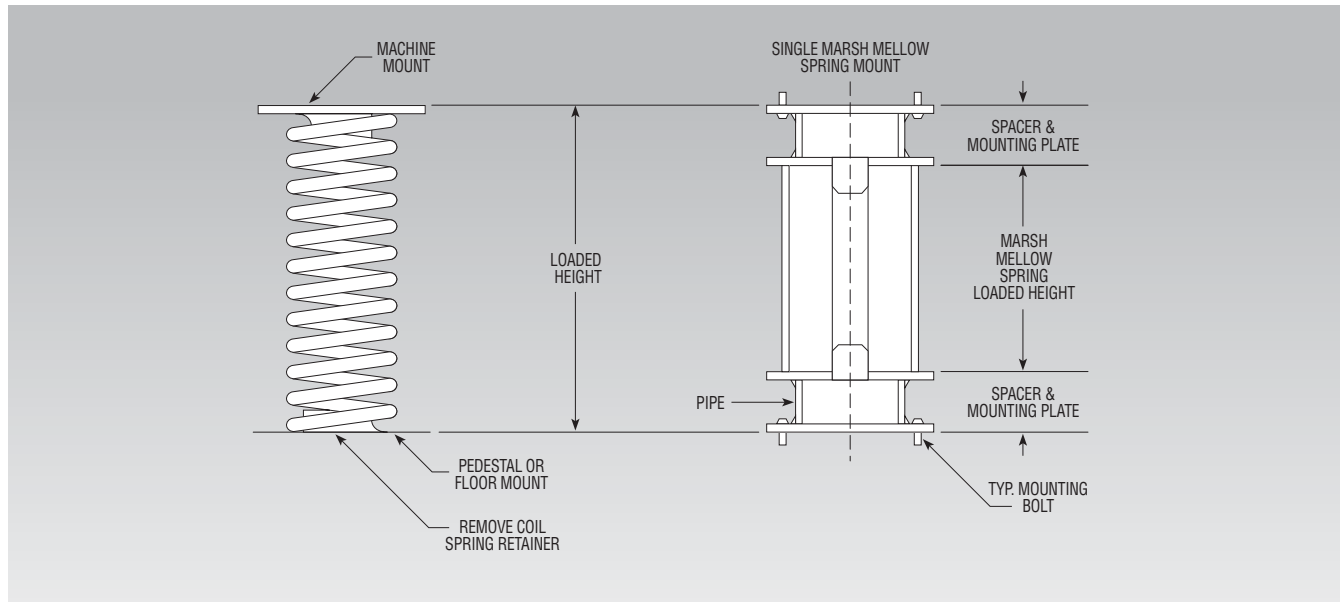

Coil Spring Replacement

1. Select the correct Marsh Mellow™ spring for the specific application following the guide lines in “Selection Procedure” of the *Marsh Mellow Spring Design Manual*.
2. Measure present spring loaded height while the machine is shut down.
3. From the Individual Marsh Mellow Spring Data Sheet, find the loaded Marsh Mellow spring height.
4. Determine the total spacer/mounting plate height required by subtracting the loaded Marsh Mellow spring height from present loaded spring height.
5. Fabricate mounting plates for the Marsh Mellow spring. Follow the same scheme shown above.
6. Raise the machine. Remove the existing spring. Prepare the mounting surface, and insert the Marsh Mellow spring assembly with upper and lower mounting plates in place.
7. Carefully lower the machine on mounting plates, making sure the upper and lower mounting plates are in line vertically at all support points.
8. Follow steps 5-9 of “Vibration Isolation New Installation” for final installation.

Installation

Miscellaneous Mounting Arrangements

The following mounting arrangements shown below are for various applications. If your application requires such an arrangement and additional information is required, please call Firestone Industrial Products.

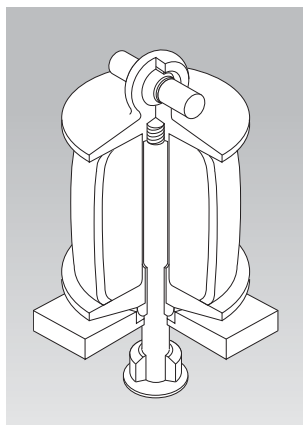

Shock Impact

The center rod arrangement provides an ideal system to utilize the Marsh Mellow™ spring in shock impact applications. This design provides lateral stability in a high damping application.

Tension Retainer

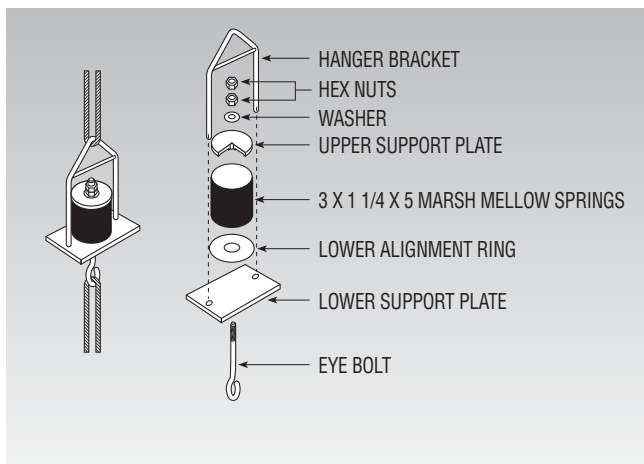

Hanging Vibrator Screen Mount

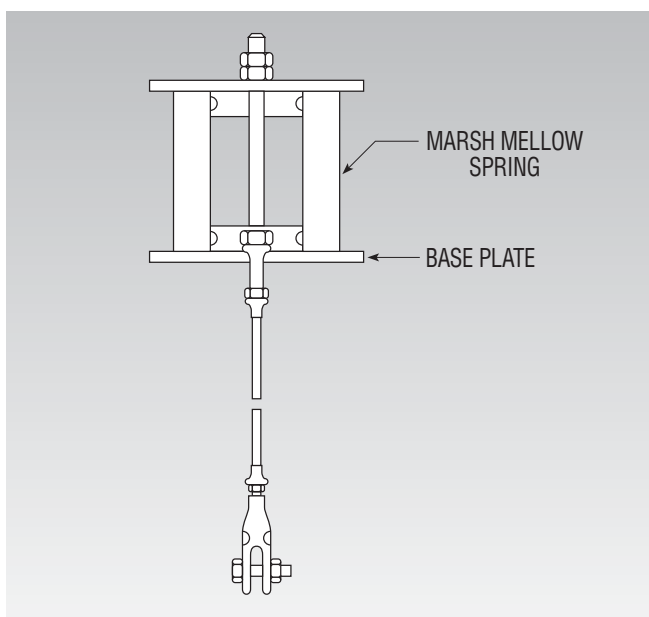

Applications

Vibration Isolation

Bin Hopper

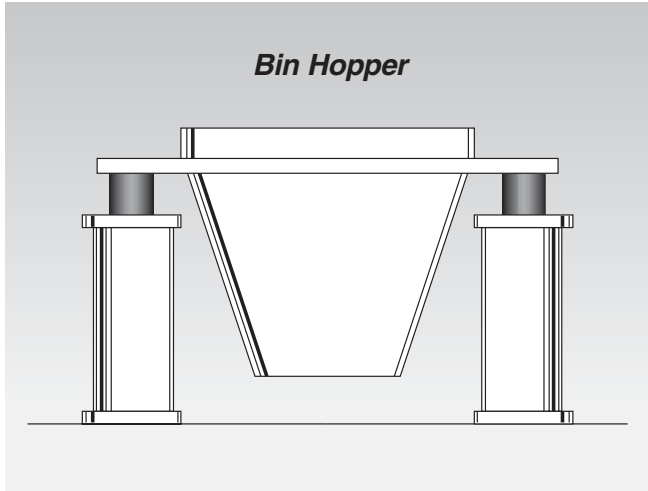

Compressor

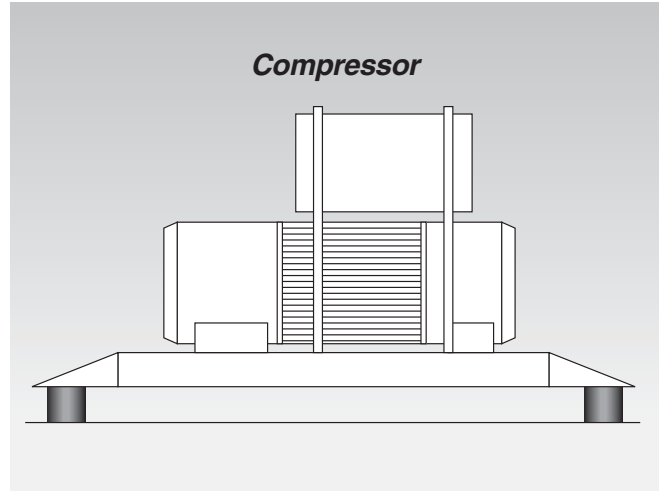

Blower and Motor

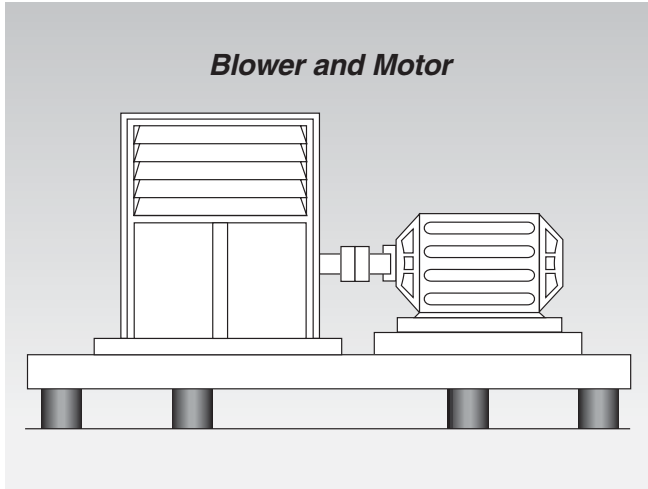

Vibrating Screen

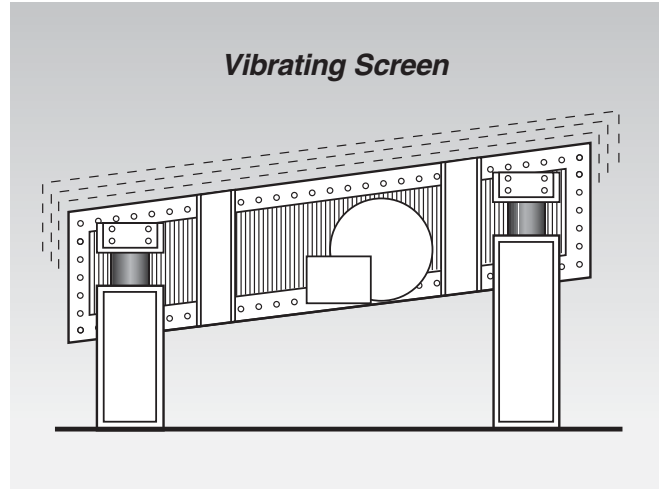

Shock Impact

Shock absorption is a natural application for Marsh Mellow™ springs. Suitable for cranes, hammers, bumpers, and similar applications.

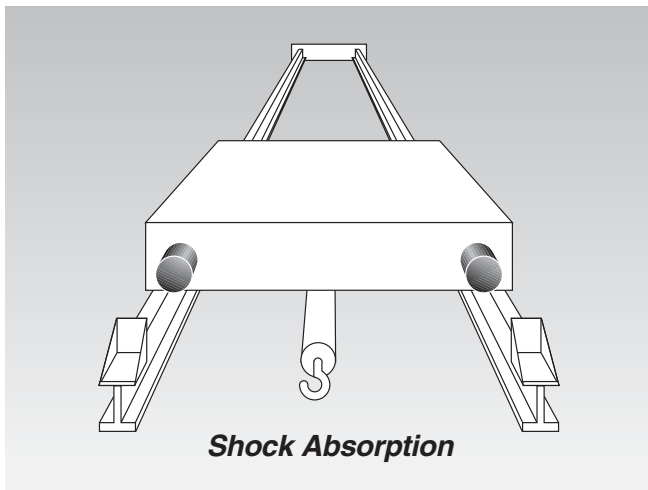

Shock Absorption

Tag Line

Tag lines are usually required for inclined screens or screens with off-mounted pivot motors. Consider using Marsh Mellow spring tension bands. Marsh Mellow spring tension bands are constructed with just the fabric reinforced plies and serve as an industrial strength band.

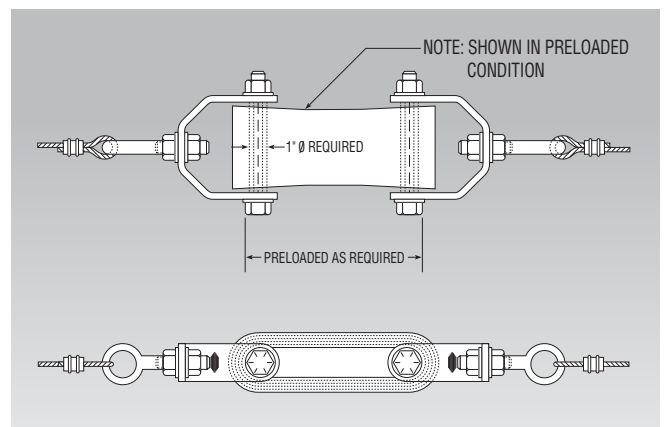

Firestone Marsh Mellow™ Spring Selection Guide *(Imperial)*

Load Requirements

Marsh Mellow Spring	Data Page	UNLOADED SIZE			MINIMUM LOADING			MAXIMUM LOADING		
		Outside Diameter (in)	Inside Diameter (in)	Free Height (in)	Minimum Loading (lbs)	Compressed Height (in)	Natural Frequency (CPM)	Maximum Loading (lbs)	Compressed Height (in)	Natural Frequency (CPM)
W22-358-0216	32	1⅞	⅝	1¾	145	1.50	414	315	1.27	304
W22-358-0031	34	3¼	1¼	5	400	4.25	251	900	3.63	186
W22-358-0183	35	3	1	4	350	3.40	230	680	2.90	242
W22-358-0047	36	3	1	4	420	3.40	246	910	2.90	228
W22-358-0030	37	3	1	3	475	2.55	293	925	2.18	216
W22-358-0180	38	4	2	6	530	5.10	218	1100	4.35	162
W22-358-0123	39	3½	1	6	570	5.10	223	1225	4.35	165
W22-358-0178	40	4½	2	6	720	5.10	235	1690	4.35	173
W22-358-0091	41	4½	1	7	1120	5.95	213	2550	5.08	158
W22-358-0064	42	5	1	7	1400	5.95	210	2860	5.08	165
W22-358-0172	43	6	3	6	1400	5.10	208	3080	4.35	192
W22-358-0186	44	6½	3	8	1530	6.80	195	3350	5.80	144
W22-358-0187	45	5½	2	7	1540	5.95	182	3280	5.08	181
W22-358-0200	46	6	1	6	1765	5.10	232	4050	4.35	171
W22-358-0190	48	6½	2	8	1990	6.80	186	4400	5.80	160
W22-356-0122	49	6	1	8	2180	6.80	192	4670	5.80	142
W22-358-0179	50	7½	3½	8	2300	6.80	180	5150	5.80	164
W22-358-0176	51	7½	3½	10	2300	8.50	175	5300	7.25	144
W22-358-0228	52	8	3½	12	2700	10.20	158	5870	8.70	116
W22-358-0232	53	8	2	8	3800	6.80	188	8400	5.80	178
W22-358-0230	54	9	2	8	5200	6.80	182	11400	5.80	151
W22-358-0108	55	10	2	14	5500	11.90	148	12250	10.15	110
W22-358-0254	56	10	2	8	6600	6.80	199	15000	5.80	159
W22-358-0143	57	11	2	6	8200	5.10	220	20000	4.35	204
W22-358-0243	58	11	2	8	8300	6.80	195	19600	5.80	138

The individual data pages for the tension bands W22-358-0215 and W22-358-0275 are on pages 59 and 60 respectively.

Stroke Requirements

Marsh Mellow Spring	Data Page	UNLOADED SIZE			Maximum Allowable Stroke @ 800 1200 CPM (in)	MINIMUM LOADING			MAXIMUM LOADING		
		Outside Diameter (in)	Inside Diameter (in)	Free Height (in)		Required Stroke (in)	Allowable Static Height Range (in)	Allowable Load Range (lbs)	Required Stroke (in)	Allowable Static Height Range (in)	Allowable Load Range (lbs)
W22-358-0216	32	1½	⅝	1¾	0.13	.13 to .09	1.49 to 1.31	145 to 280	.09 or less	1.49 to 1.27	145 to 315
W22-358-0031	34	¾	1¼	5	0.38	.38 to .25	4.25 to 3.75	400 to 800	.25 or less	4.25 to 3.83	400 to 900
W22-358-0183	35	3	1	4	0.30	.30 to .20	3.40 to 3.00	350 to 580	.20 or less	3.40 to 2.90	350 to 680
W22-358-0047	36	3	1	4	0.30	.30 to .20	3.40 to 3.00	420 to 790	.20 or less	3.40 to 2.90	420 to 910
W22-358-0030	37	3	1	3	0.23	.23 to .15	2.55 to 2.25	475 to 825	.15 or less	2.55 to 2.18	475 to 925
W22-358-0180	38	4	2	6	0.45	.45 to .30	5.10 to 4.50	530 to 990	.30 or less	5.10 to 4.35	530 to 1100
W22-358-0123	39	3½	1	6	0.45	.45 to .30	5.10 to 4.50	570 to 1100	.30 or less	5.10 to 4.35	570 to 1225
W22-358-0178	40	4½	2	6	0.45	.45 to .30	5.10 to 4.50	720 to 1480	.30 or less	5.10 to 4.35	720 to 1690
W22-358-0091	41	4½	1	7	0.53	.53 to .35	5.95 to 5.25	1120 to 2220	.35 or less	5.95 to 5.08	1120 to 2550
W22-358-0064	42	5	1	7	0.53	.53 to .35	5.95 to 5.25	1400 to 2480	.35 or less	5.95 to 5.08	1400 to 2860
W22-358-0172	43	6	3	6	0.45	.45 to .30	5.10 to 4.50	1400 to 2290	.30 or less	5.10 to 4.35	1400 to 3080
W22-358-0186	44	6½	3	8	0.60	.60 to .40	6.80 to 6.00	1530 to 2970	.40 or less	6.80 to 5.80	1530 to 3350
W22-358-0187	45	5½	2	7	0.53	.53 to .35	5.95 to 5.25	1540 to 2600	.35 or less	5.95 to 5.08	1540 to 3280
W22-358-0200	46	6	1	6	0.45	.45 to .30	5.10 to 4.50	1765 to 3550	.30 or less	5.10 to 4.35	1765 to 4050
W22-358-0190	48	6½	2	8	0.60	.60 to .40	6.80 to 6.00	1990 to 3800	.40 or less	6.80 to 5.80	1990 to 4400
W22-358-0122	49	6	1	8	0.60	.60 to .40	6.80 to 6.00	2180 to 4100	.40 or less	6.80 to 5.80	2180 to 4670
W22-358-0179	50	7½	3½	8	0.60	.60 to .40	6.80 to 6.00	2300 to 4070	.40 or less	6.80 to 5.80	2300 to 5150
W22-358-0176	51	7½	3½	10	0.75	.75 to .50	8.50 to 7.50	2300 to 3910	.50 or less	8.50 to 7.25	2300 to 5300
W22-358-0228	52	8	3½	12	0.90	.90 to .60	10.20 to 9.00	2700 to 5100	.60 or less	10.20 to 8.70	2700 to 5870
W22-358-0232	53	8	2	8	0.60	.60 to .40	6.80 to 6.00	3300 to 6600	.40 or less	6.80 to 5.80	3300 to 7900
W22-358-0230	54	9	2	8	0.60	.60 to .40	6.80 to 6.00	5200 to 10000	.40 or less	6.80 to 5.80	5200 to 11400
W22-358-0108	55	10	2	14	1.05	1.05 to .70	11.90 to 10.50	5500 to 10750	.70 or less	11.90 to 10.15	5500 to 12250
W22-358-0254	56	10	2	8	0.60	.60 to .40	6.80 to 6.00	6600 to 13000	.40 or less	6.80 to 5.80	6600 to 15000
W22-358-0143	57	11	2	6	0.45	.45 to .30	5.10 to 4.50	8200 to 15500	.30 or less	5.10 to 4.35	8200 to 20000
W22-358-0243	58	11	2	8	0.60	.60 to .40	6.80 to 6.00	8300 to 16200	.40 or less	6.80 to 5.80	8300 to 19600

The individual data pages for the tension bands W22-358-0215 and W22-358-0275 are on pages 59 and 60 respectively.

Firestone Marsh Mellow™ Spring Selection Guide *(Metric)*

Load Requirements

Marsh Mellow Spring	Data Page	UNLOADED SIZE			MINIMUM LOADING			MAXIMUM LOADING		
		Outside Diameter (mm)	Inside Diameter (mm)	Free Height (mm)	Minimum Loading (kN)	Compressed Height (mm)	Natural Frequency (Hz)	Maximum Loading (kN)	Compressed Height (mm)	Natural Frequency (Hz)
W22-358-0216	32	41	16	44	0.64	38	6.90	1.40	32	5.07
W22-358-0031	34	83	32	127	1.78	108	4.18	4.00	92	3.10
W22-358-0183	35	76	25	102	1.56	86	3.85	3.02	74	4.03
W22-358-0047	36	76	25	102	1.87	86	2.90	4.04	74	2.69
W22-358-0030	37	76	25	76	2.11	65	4.88	4.11	55	3.60
W22-358-0180	38	102	51	152	2.36	130	3.63	4.89	110	2.70
W22-358-0123	39	89	25	152	2.53	130	3.72	5.44	110	2.75
W22-358-0178	40	114	51	152	3.20	130	3.92	7.51	110	2.88
W22-358-0091	41	114	25	178	4.98	151	3.55	11.33	129	2.63
W22-358-0064	42	127	25	178	6.22	151	3.50	12.71	129	2.75
W22-358-0172	43	152	76	152	6.22	130	3.47	13.69	110	3.19
W22-358-0186	44	165	76	203	6.80	173	3.25	14.89	147	2.40
W22-358-0187	45	140	51	178	6.84	151	3.03	14.58	129	3.02
W22-358-0200	46	152	25	152	7.84	130	3.87	18.00	110	2.85
W22-358-0190	48	165	51	203	8.84	173	3.10	19.56	147	2.67
W22-356-0122	49	152	25	203	9.69	173	3.20	20.76	147	2.37
W22-358-0179	50	191	89	203	10.22	173	2.99	22.89	147	2.73
W22-358-0176	51	191	89	254	10.22	216	2.92	23.56	184	2.40
W22-358-0228	52	203	89	305	12.00	259	2.63	26.09	221	1.93
W22-358-0232	53	203	51	203	16.89	173	3.13	37.33	147	2.97
W22-358-0230	54	229	51	203	23.11	173	3.03	50.67	147	2.52
W22-358-0108	55	254	51	356	24.44	302	2.47	54.44	258	1.83
W22-358-0254	56	254	51	203	29.33	173	3.32	66.67	147	2.65
W22-358-0143	57	279	51	152	36.44	130	3.66	88.89	110	3.4
W22-358-0243	58	279	51	203	36.89	173	3.25	87.11	147	2.31

The individual data pages for the tension bands W22-358-0215 and W22-358-0275 are on pages 59 and 60 respectively.

Stroke Requirements

Marsh Mellow Spring	Data Page	UNLOADED SIZE			Maximum Allowable Stroke @ 800 1200 CPM (mm)	MINIMUM LOADING			MAXIMUM LOADING		
		Outside Diameter (mm)	Inside Diameter (mm)	Free Height (mm)		Required Stroke (mm)	Allowable Static Height Range (mm)	Allowable Load Range (kN)	Required Stroke (mm)	Allowable Static Height Range (mm)	Allowable Load Range (kN)
W22-358-0216	32	41	16	44	3	3 to 2	38 to 33	0.64 to 1.24	2 or less	38 to 32	0.64 to 1.40
W22-358-0031	34	83	32	127	10	10 to 6	108 to 95	1.78 to 3.56	6 or less	108 to 97	1.78 to 4.00
W22-358-0183	35	76	25	102	8	8 to 5	86 to 76	1.56 to 2.58	5 or less	86 to 74	1.56 to 3.02
W22-358-0047	36	76	25	102	8	8 to 5	86 to 76	1.87 to 3.51	5 or less	86 to 74	1.87 to 4.04
W22-358-0030	37	76	25	76	6	6 to 4	65 to 57	2.11 to 3.67	4 or less	65 to 55	2.11 to 4.11
W22-358-0180	38	102	51	152	11	11 to 8	130 to 114	2.36 to 4.40	8 or less	130 to 110	2.36 to 4.89
W22-358-0123	39	89	25	152	11	11 to 8	130 to 114	2.53 to 4.89	8 or less	130 to 110	2.53 to 5.44
W22-358-0178	40	114	51	152	11	11 to 8	130 to 114	3.20 to 6.58	8 or less	130 to 110	3.20 to 7.51
W22-358-0091	41	114	25	178	13	13 to 9	151 to 133	4.98 to 9.87	9 or less	151 to 129	4.98 to 11.33
W22-358-0064	42	127	25	178	13	13 to 9	151 to 133	6.22 to 11.02	9 or less	151 to 129	6.22 to 12.71
W22-358-0172	43	152	76	152	11	11 to 8	130 to 114	6.22 to 10.18	8 or less	130 to 110	6.22 to 13.69
W22-358-0186	44	165	76	203	15	15 to 10	173 to 152	6.80 to 13.20	10 or less	173 to 147	6.80 to 14.89
W22-358-0187	45	140	51	178	13	13 to 9	151 to 133	6.84 to 11.56	9 or less	151 to 129	6.84 to 14.58
W22-358-0200	46	152	25	152	11	11 to 8	130 to 114	7.84 to 15.78	8 or less	130 to 110	7.84 to 18.00
W22-358-0190	48	165	51	203	15	15 to 10	173 to 152	8.84 to 16.89	10 or less	173 to 147	8.84 to 19.56
W22-358-0122	49	152	25	203	15	15 to 10	173 to 152	9.69 to 18.22	10 or less	173 to 147	9.69 to 20.76
W22-358-0179	50	191	89	203	15	15 to 10	173 to 152	10.22 to 18.09	10 or less	173 to 147	10.22 to 22.89
W22-358-0176	51	191	89	254	19	19 to 13	216 to 191	10.22 to 17.38	13 or less	216 to 184	10.22 to 23.56
W22-358-0228	52	203	89	305	23	23 to 15	259 to 229	12.00 to 22.67	15 or less	259 to 221	12.00 to 26.09
W22-358-0232	53	203	51	203	15	15 to 10	173 to 152	14.67 to 29.33	10 or less	173 to 147	14.67 to 35.11
W22-358-0230	54	229	51	203	15	15 to 10	173 to 152	23.11 to 44.44	10 or less	173 to 147	23.11 to 50.67
W22-358-0108	55	254	51	356	27	27 to 18	302 to 267	24.44 to 47.78	18 or less	302 to 258	24.44 to 54.44
W22-358-0254	56	254	51	203	15	15 to 10	173 to 152	29.33 to 57.78	10 or less	173 to 147	29.33 to 66.67
W22-358-0143	57	279	51	152	11	11 to 8	130 to 114	36.44 to 68.89	8 or less	130 to 110	36.44 to 88.89
W22-358-0243	58	279	51	203	15	15 to 10	173 to 152	36.89 to 72.00	10 or less	173 to 147	36.89 to 87.11

The individual data pages for the tension bands W22-358-0215 and W22-358-0275 are on pages 59 and 60 respectively.

IMPERIAL

Compression (%)	15.0	20.0	22.5	25.0	27.5
Load (lbs.)	145	210	245	280	315
Height (in.)	1.49	1.40	1.36	1.31	1.27
Rate (lbs./in.)	705	760	783	805	826
Effective Deflection (in.)	0.2	0.3	0.3	0.3	0.4
Natural Freq. (CPM)	414	358	336	319	304
Maximum OD (in.)	2.5				
Weight (lbs.)	0.12				

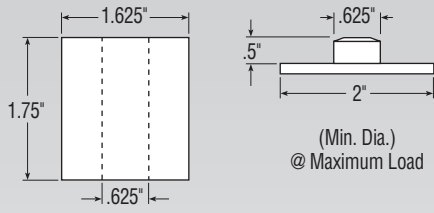

METRIC

Compression (%)	15.0	20.0	22.5	25.0	27.5
Load (kN)	0.64	0.93	1.09	1.24	1.40
Height (mm)	38	36	35	33	32
Rate (kN/m)	123	132	137	140	144
Effective Deflection (mm)	5	8	8	8	10
Natural Freq. (Hz)	6.90	5.97	5.60	5.32	5.07
Maximum OD (mm)	64				
Weight (kg)	0.05				

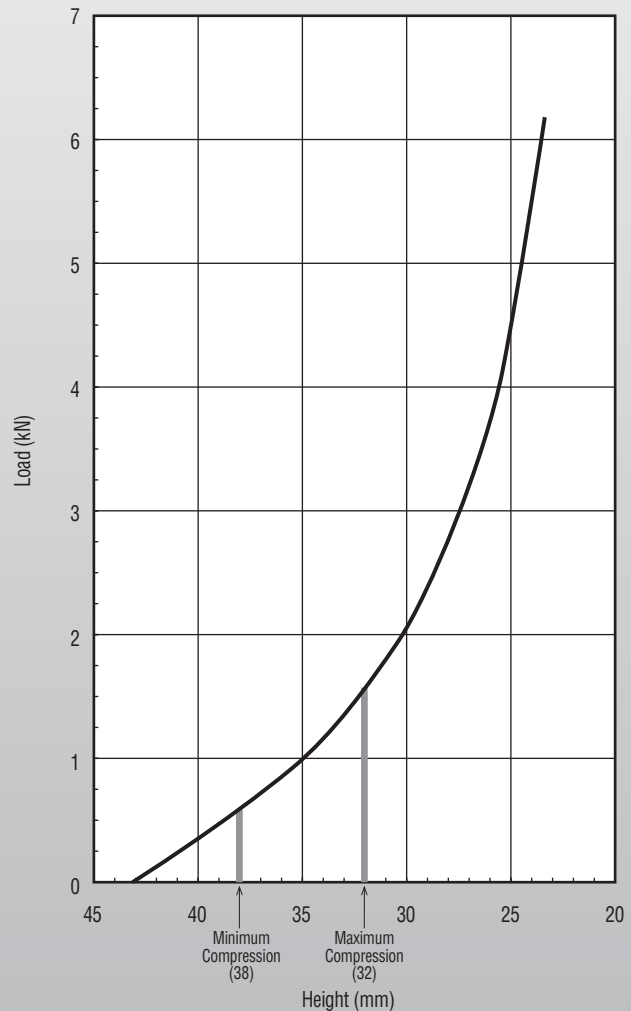
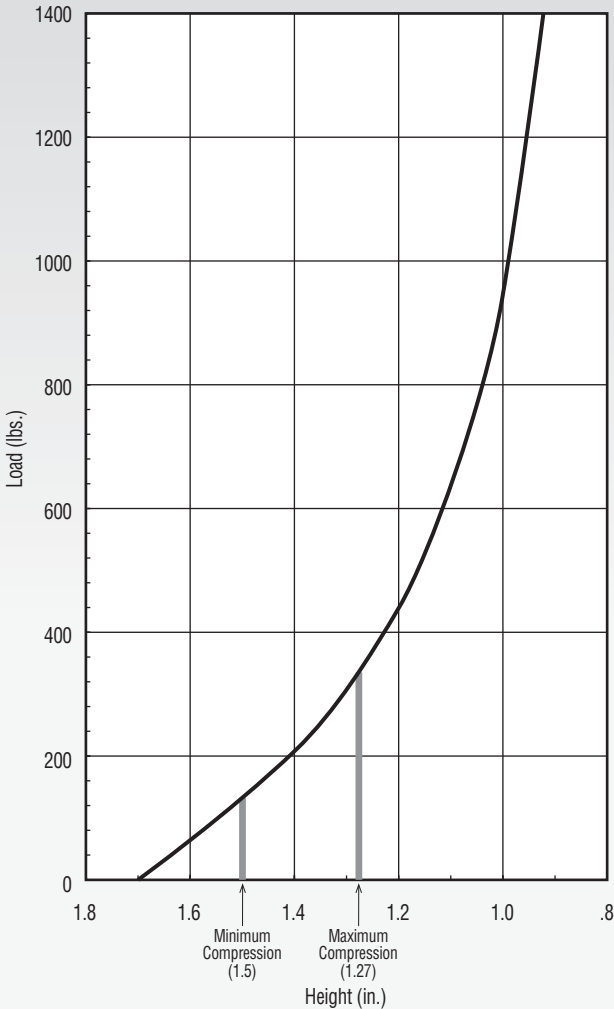
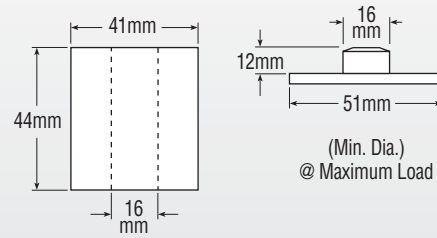

IMPERIAL

Compression (%)	15.0	20.0	22.5	25.0	27.5
Load (lbs.)	400	595	685	800	900
Height (in.)	4.3	4.0	3.9	3.8	3.6
Rate (lbs./in.)	716	790	822	852	880
Effective Deflection (in.)	0.6	0.8	0.8	0.9	1.0
Natural Freq. (CPM)	252	217	206	194	186
Maximum OD (in.)	4.1				
Weight (lbs.)	1.22				

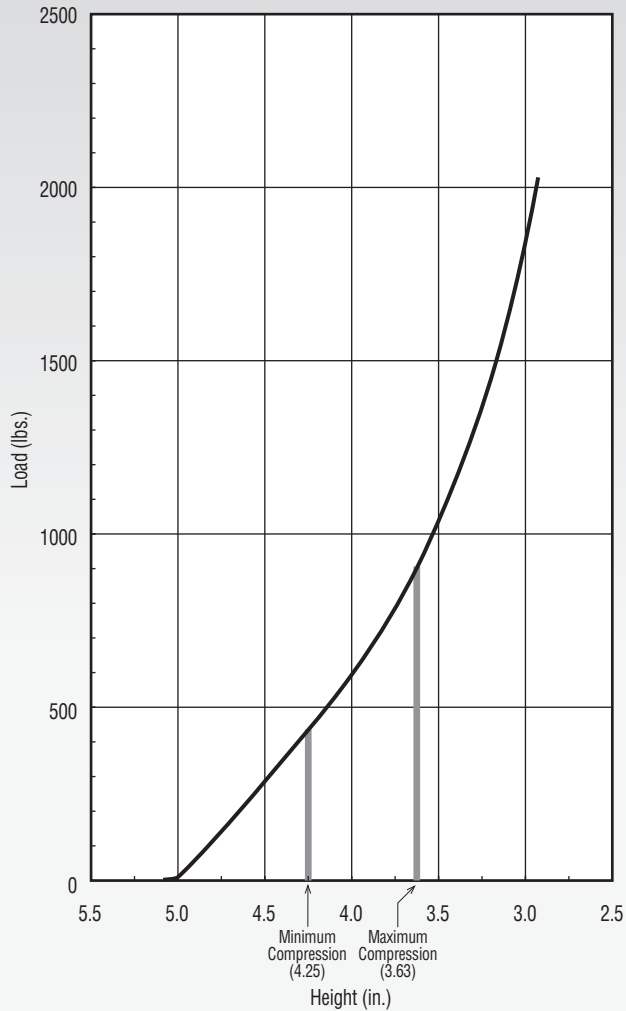
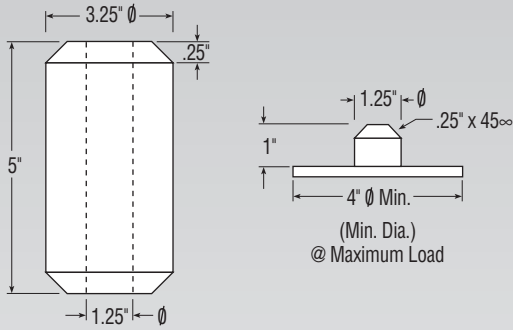

METRIC

Compression (%)	15.0	20.0	22.5	25.0	27.5
Load (kN)	1.78	2.64	3.04	3.56	4.00
Height (mm)	109	102	99	97	91
Rate (kN/m)	125	138	144	149	154
Effective Deflection (mm)	15	20	20	23	25
Natural Freq. (Hz)	4.20	3.62	3.43	3.23	3.10
Maximum OD (mm)	104				
Weight (kg)	0.56				

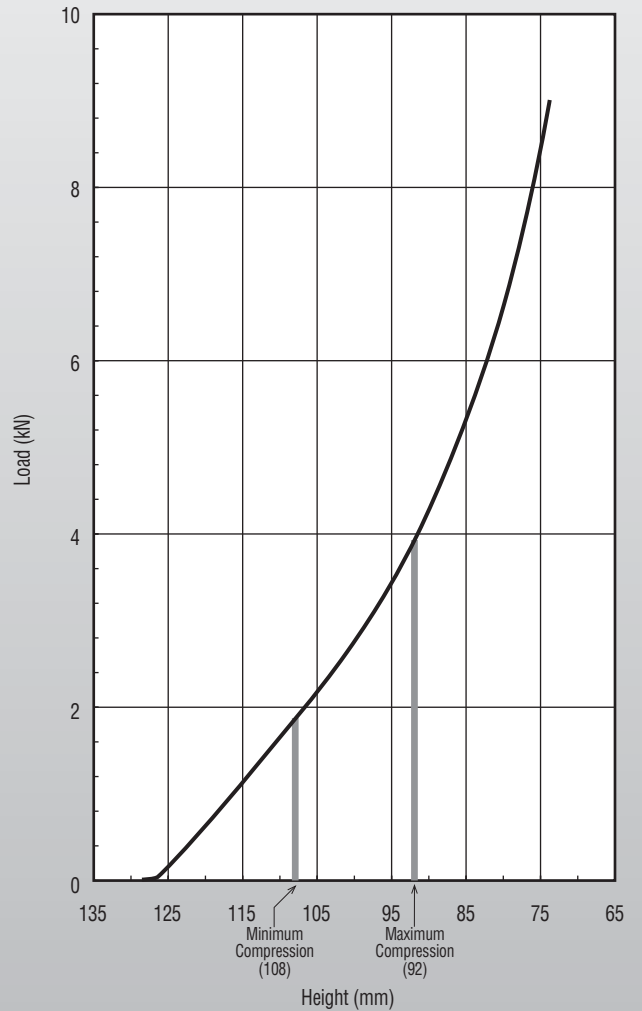
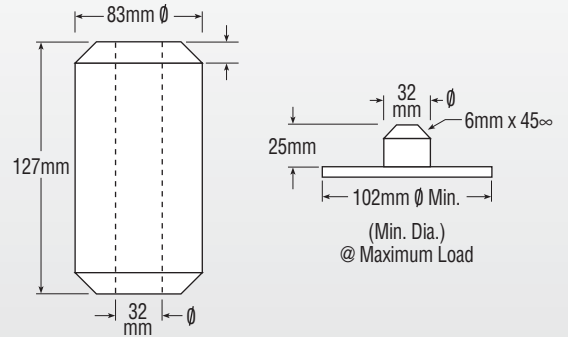

IMPERIAL

Compression (%)	15.0	20.0	22.5	25.0	27.5
Load (lbs.)	350	440	500	580	680
Height (in.)	3.4	3.2	3.1	3.0	2.9
Rate (lbs./in.)	525	531	695	892	1122
Effective Deflection (in.)	0.7	0.8	0.7	0.7	0.6
Natural Freq. (CPM)	230	207	222	233	242
Maximum OD (in.)	3.2	3.3	3.4	3.4	3.5
Weight (lbs.)	0.93				

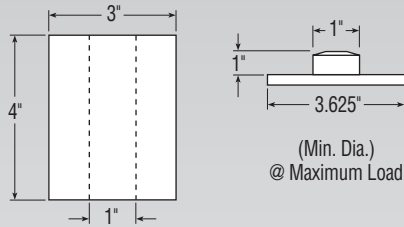

METRIC

Compression (%)	15.0	20.0	22.5	25.0	27.5
Load (kN)	1.56	1.96	2.22	2.58	3.02
Height (mm)	86	81	79	76	74
Rate (kN/m)	92	93	122	156	196
Effective Deflection (mm)	18	20	18	18	15
Natural Freq. (Hz)	3.85	3.45	3.70	3.88	4.03
Maximum OD (mm)	81	84	86	86	89
Weight (kg)	0.42				

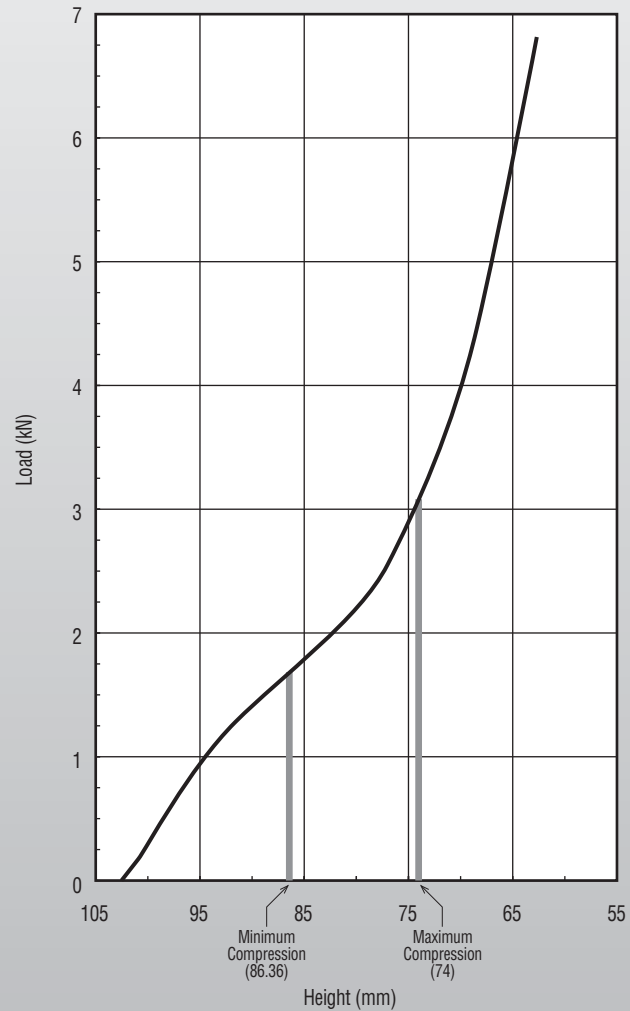
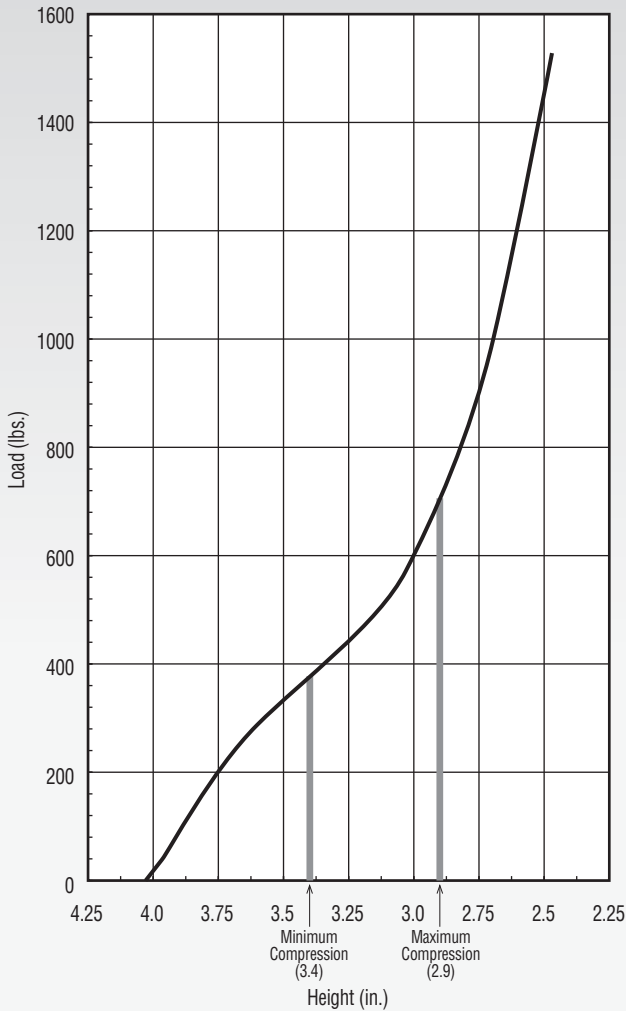
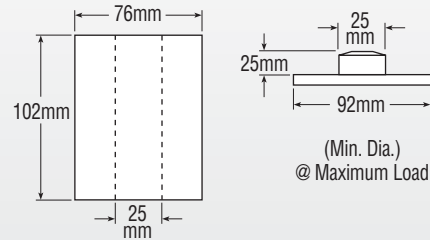

IMPERIAL

Compression (%)	15	20	22.5	25	27.5
Load (lbs.)	420	600	690	790	910
Height (in.)	3.4	3.2	3.1	3	2.9
Rate (lbs./in.)	720	840	980	1080	1340
Effective Deflection (in.)	0.58	0.71	0.70	0.73	0.68
Natural Freq. (CPM)	246	222	224	220	228
Maximum OD (in.)	3.28	3.3	3.35	3.4	3.46
Weight (lbs.)	0.94				

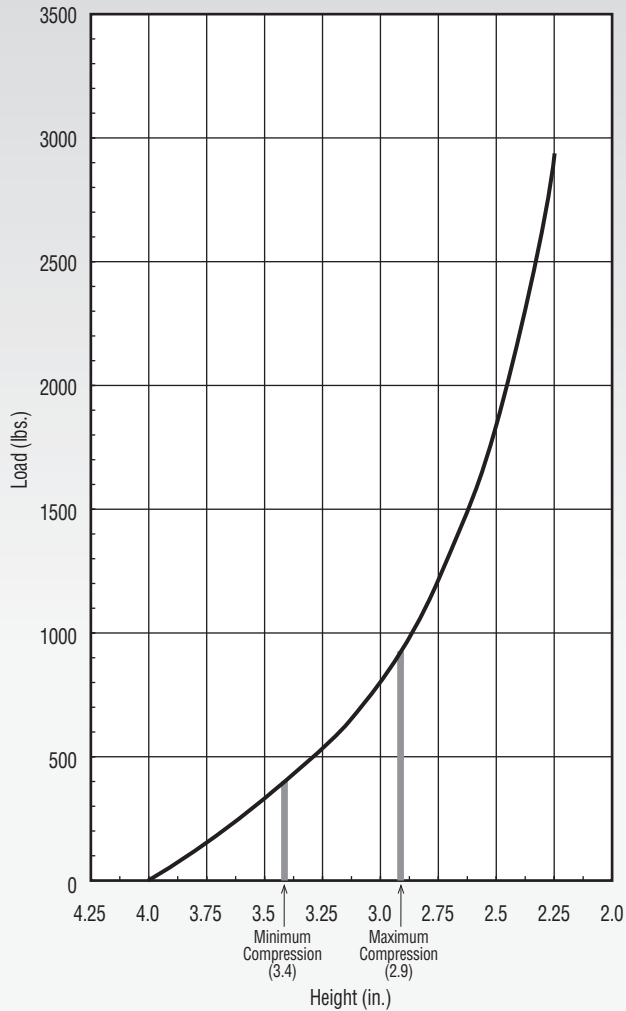
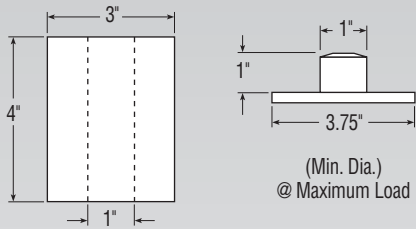

METRIC

Compression (%)	15	20	22.5	25	27.5
Load (kN)	1.87	2.67	3.07	3.51	4.04
Height (mm)	86	81	79	76	74
Rate (kN/m)	126	147	171	189	234
Effective Deflection (mm)	15	18	18	19	17
Natural Freq. (Hz)	4.10	3.71	3.73	3.66	3.80
Maximum OD (mm.)	83	84	85	86	88
Weight (kg)	0.43				

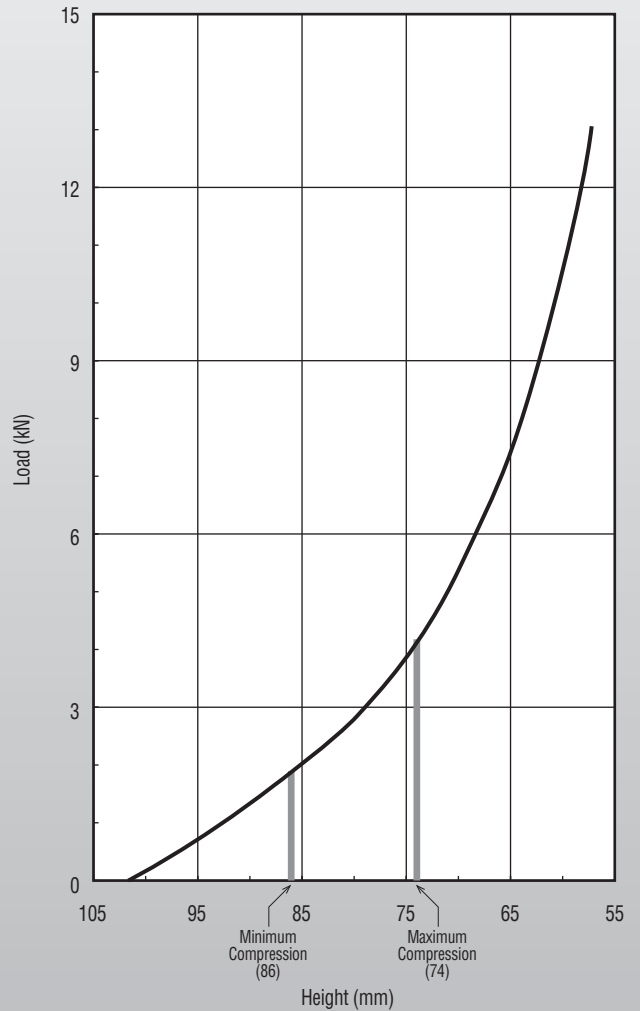
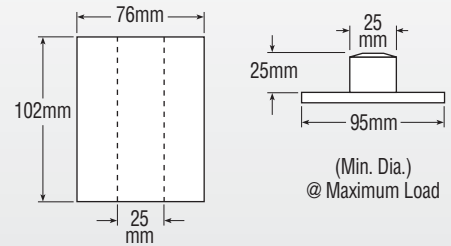

IMPERIAL

Compression (%)	15.0	20.0	22.5	25.0	27.5
Load (lbs.)	475	650	725	825	925
Height (in.)	2.6	2.4	2.33	2.25	2.2
Rate (lbs./in.)	1314	1085	1138	1322	1591
Effective Deflection (in.)	0.4	0.6	0.6	0.6	0.6
Natural Freq. (CPM)	313	243	236	238	247
Maximum OD (in.)	4.1				
Weight (lbs.)	0.68				

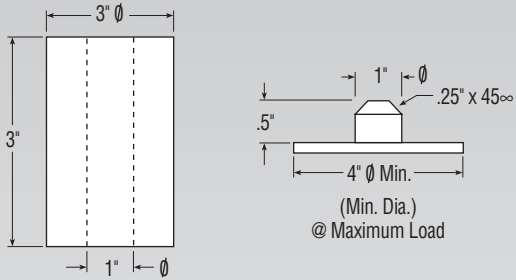

METRIC

Compression (%)	15.0	20.0	22.5	25.0	27.5
Load (kN)	2.11	2.89	3.22	3.67	4.11
Height (mm)	66	61	59	57	56
Rate (kN/m)	230	190	199	231	278
Effective Deflection (mm)	10	15	15	15	15
Natural Freq. (Hz)	5.22	4.05	3.93	3.97	4.12
Maximum OD (mm)	104				
Weight (kg)	0.31				

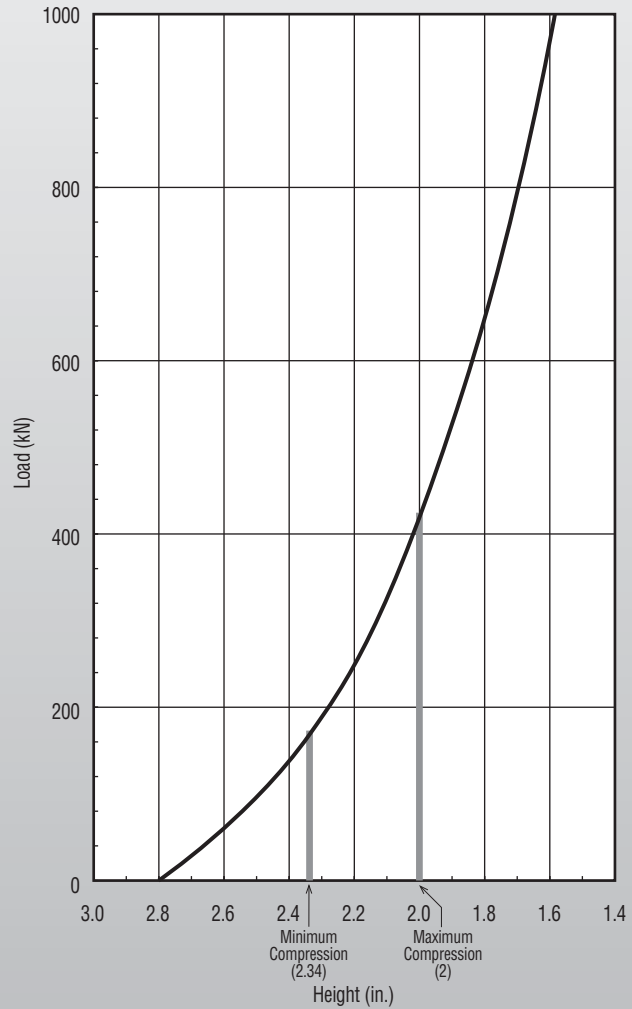
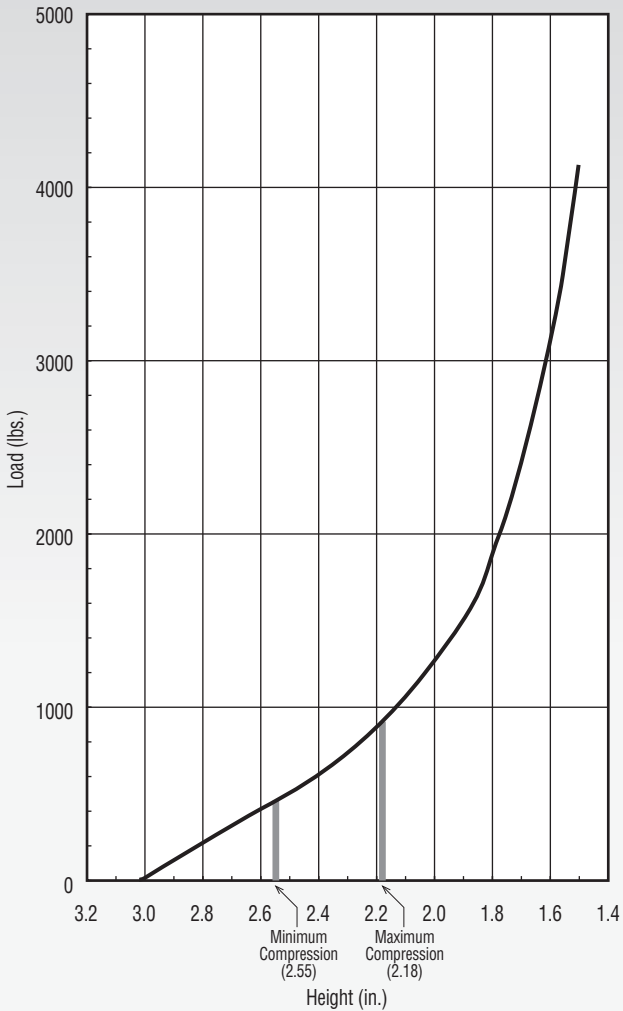
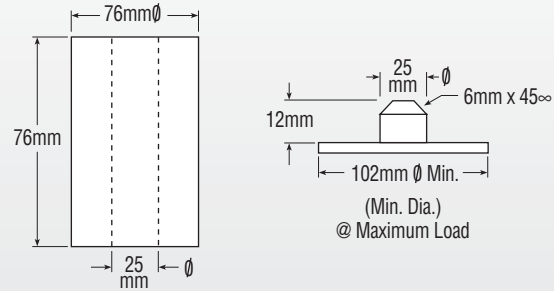

IMPERIAL

Compression (%)	15.0	20.0	22.5	25.0	27.5
Load (lbs.)	530	750	870	990	1100
Height (in.)	5.1	4.8	4.7	4.5	4.4
Rate (lbs./in.)	714	759	779	796	813
Effective Deflection (in.)	0.7	1.0	1.1	1.2	1.4
Natural Freq. (CPM)	218	189	178	169	162
Maximum OD (in.)	4.3	4.4	4.5	4.5	4.7
Weight (lbs.)	2.08				

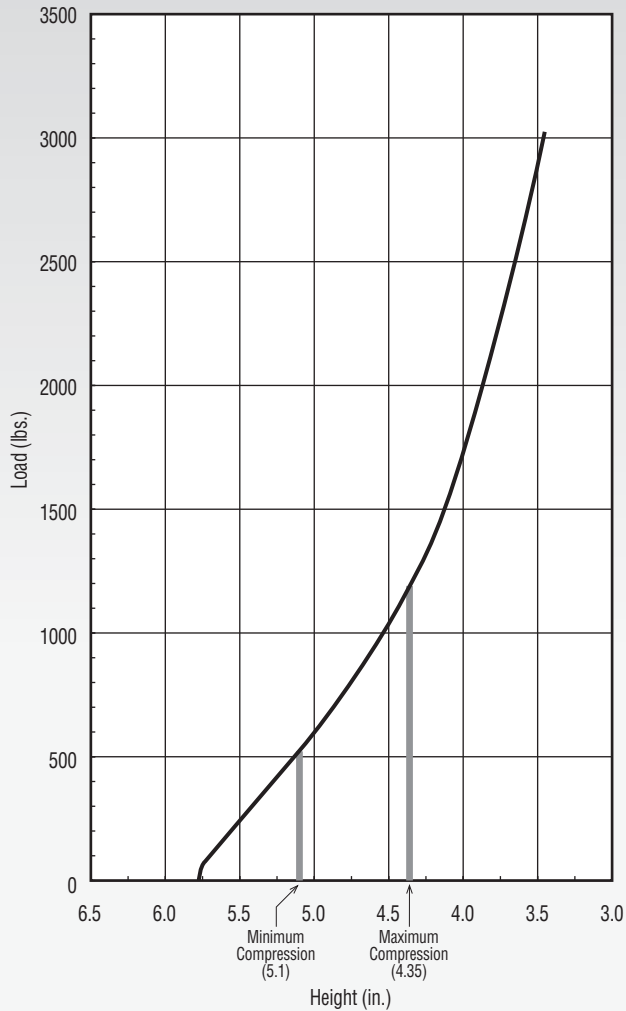
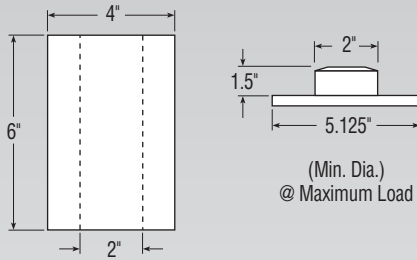

METRIC

Compression (%)	15.0	20.0	22.5	25.0	27.5
Load (kN)	2.36	3.33	3.87	4.40	4.89
Height (mm)	130	122	119	114	112
Rate (kN/m)	125	133	136	139	142
Effective Deflection (mm)	18	25	28	30	36
Natural Freq. (Hz)	3.63	3.15	2.97	2.82	2.70
Maximum OD (mm)	109	112	114	114	119
Weight (kg)	0.95				

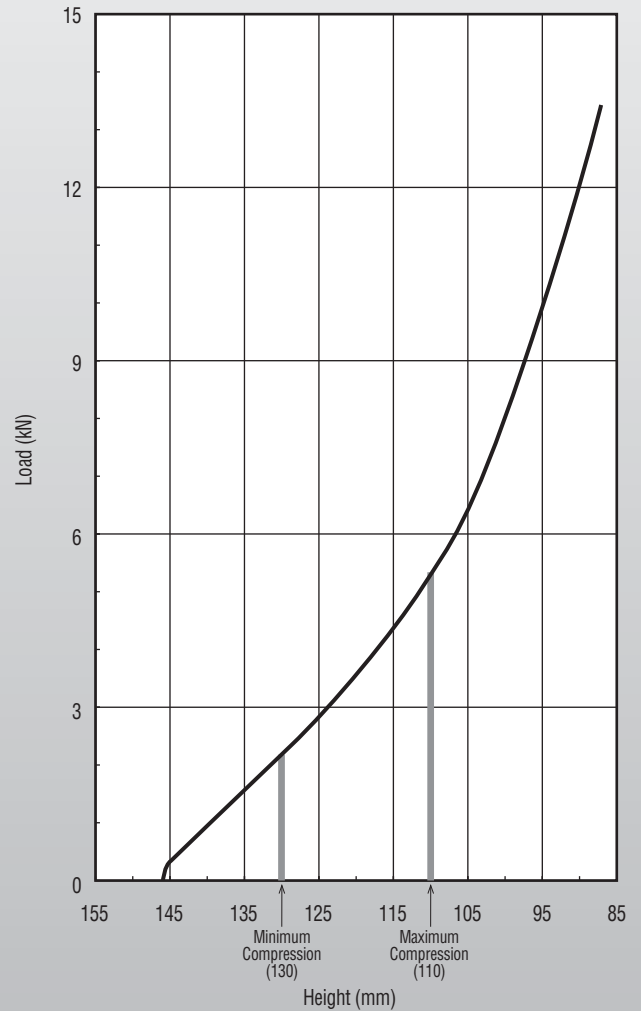
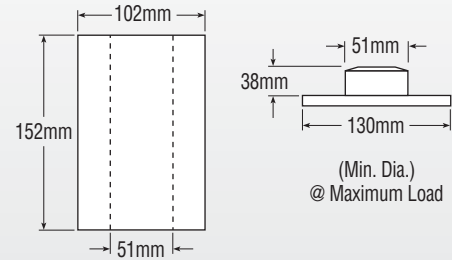

IMPERIAL

Compression (%)	15.0	20.0	22.5	25.0	27.5
Load (lbs.)	570	825	950	1100	1225
Height (in.)	5.1	4.8	4.7	4.5	4.4
Rate (lbs./in.)	804	869	897	923	947
Effective Deflection (in.)	0.7	0.9	1.1	1.2	1.3
Natural Freq. (CPM)	223	193	183	172	165
Maximum OD (in.)	4.2				
Weight (lbs.)	1.90				

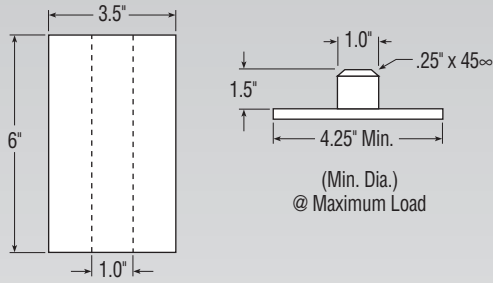

METRIC

Compression (%)	15.0	20.0	22.5	25.0	27.5
Load (kN)	2.53	3.67	4.22	4.89	5.44
Height (mm)	130	122	119	114	112
Rate (kN/m)	141	152	157	162	166
Effective Deflection (mm)	18	23	28	30	33
Natural Freq. (Hz)	3.72	3.22	3.05	2.87	2.75
Maximum OD (mm)	107				
Weight (kg)	0.87				

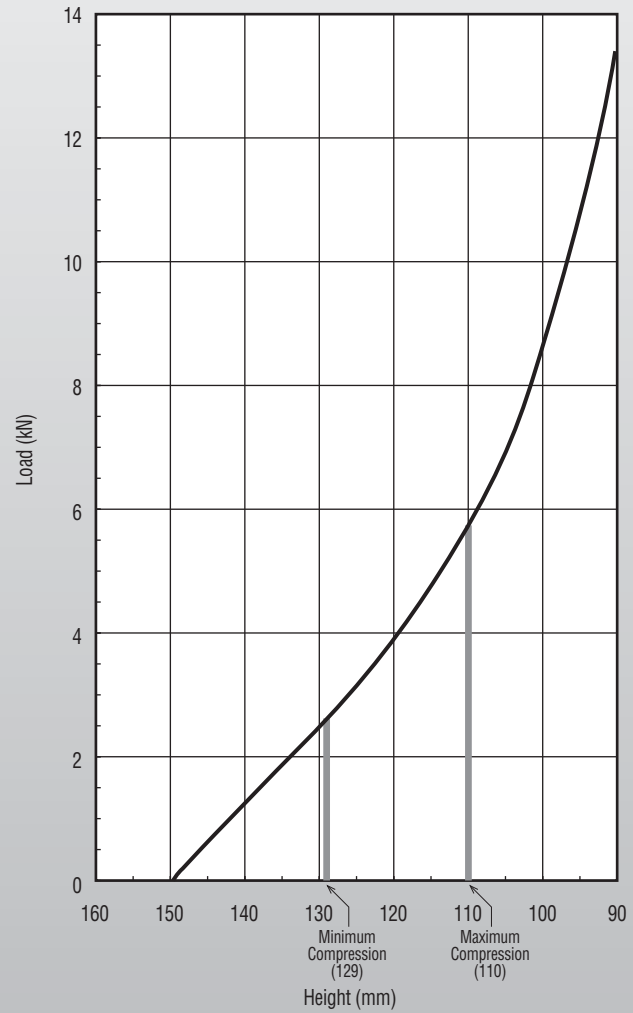
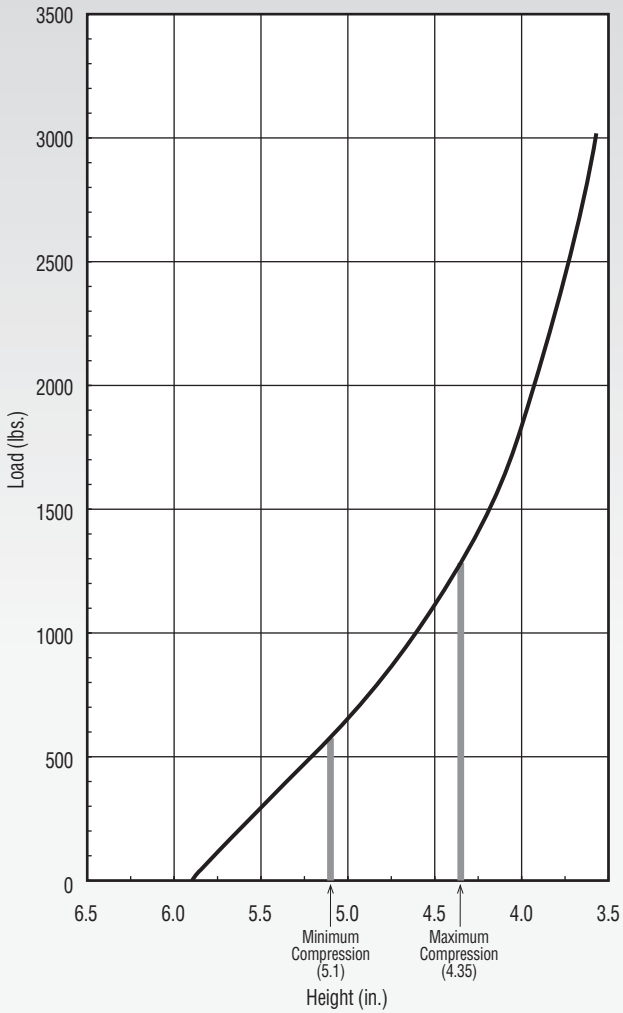
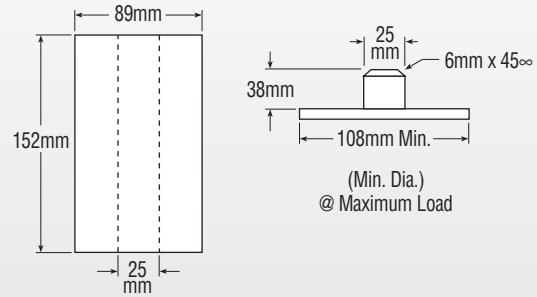

IMPERIAL

Compression (%)	15.0	20.0	22.5	25.0	27.5
Load (lbs.)	720	1080	1270	1480	1690
Height (in.)	5.1	4.8	4.7	4.5	4.4
Rate (lbs./in.)	1126	1266	1328	1387	1442
Effective Deflection (in.)	0.6	0.9	1.0	1.1	1.2
Natural Freq. (CPM)	235	204	192	182	174
Maximum OD (in.)	4.9	5.0	5.1	5.1	5.2
Weight (lbs.)	2.65				

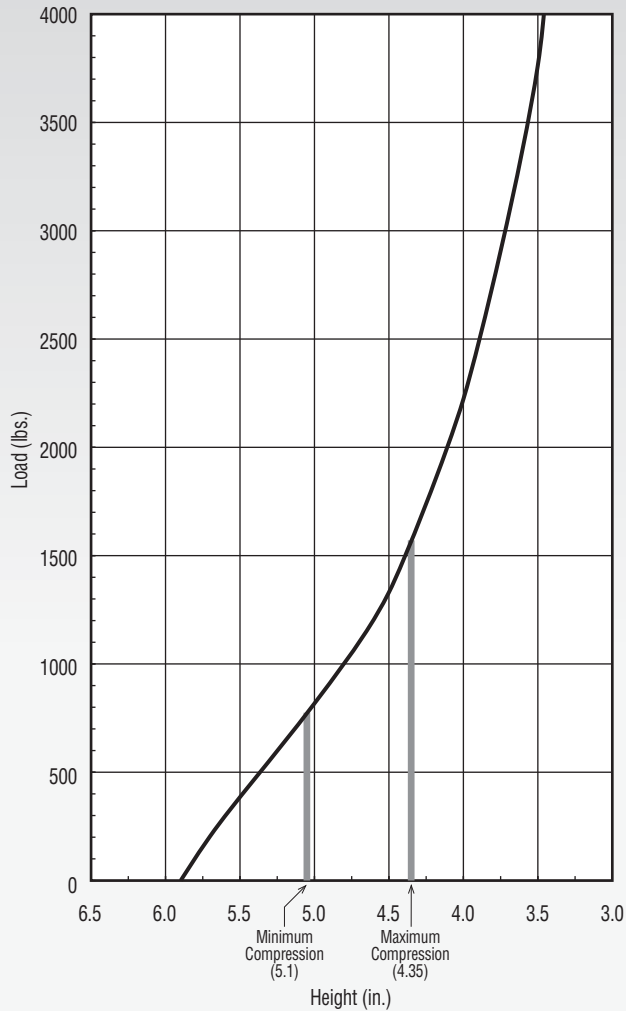
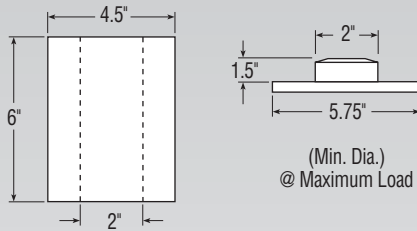

METRIC

Compression (%)	15.0	20.0	22.5	25.0	27.5
Load (kN)	3.20	4.80	5.64	6.58	7.51
Height (mm)	130	122	119	114	112
Rate (kN/m)	197	222	232	243	252
Effective Deflection (mm)	15	23	25	28	30
Natural Freq. (Hz)	3.92	3.40	3.20	3.03	2.90
Maximum OD (mm)	124	127	130	130	132
Weight (kg)	1.21				

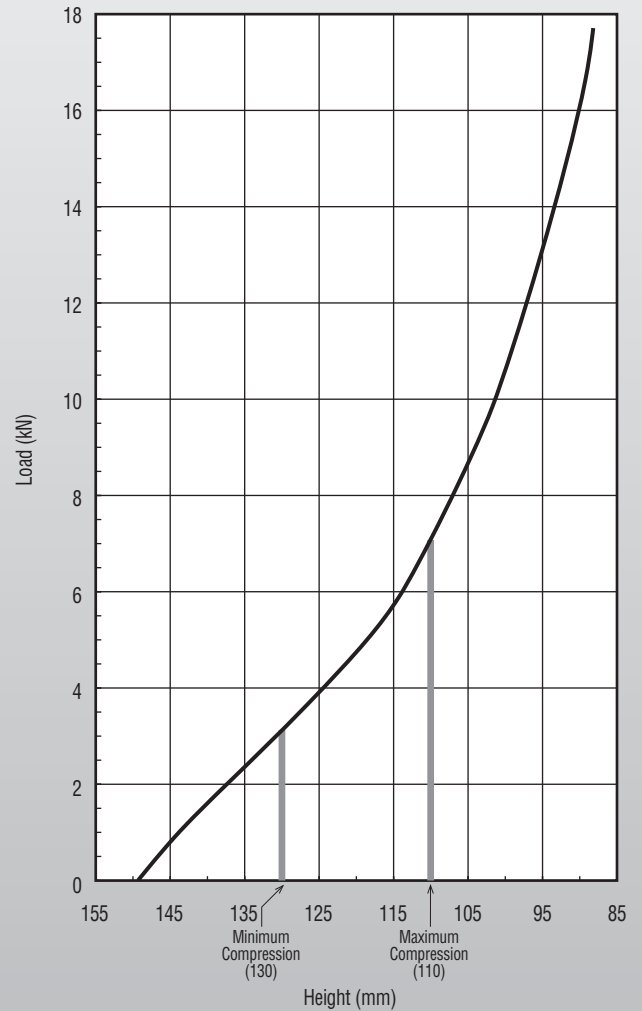
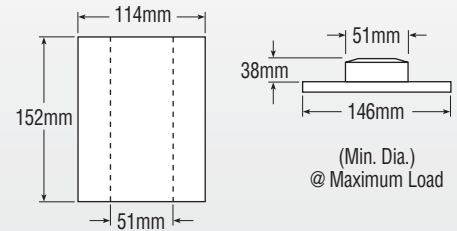

IMPERIAL

Compression (%)	15.0	20.0	22.5	25.0	27.5
Load (lbs.)	1120	1630	1950	2220	2550
Height (in.)	6.0	5.6	5.4	5.3	5.1
Rate (lbs./in.)	1442	1598	1667	1730	1790
Effective Deflection (in.)	0.8	1.0	1.2	1.3	1.4
Natural Freq. (CPM)	213	186	174	166	158
Maximum OD (in.)	4.8	4.9	5.0	5.1	5.2
Weight (lbs.)	3.76				

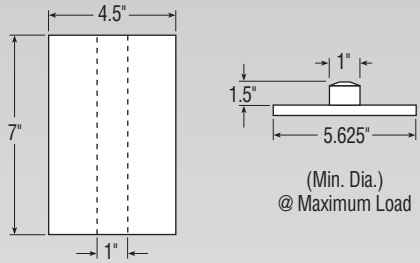

METRIC

Compression (%)	15.0	20.0	22.5	25.0	27.5
Load (kN)	4.98	7.24	8.67	9.87	11.33
Height (mm)	152	142	137	135	130
Rate (kN/m)	252	280	292	303	313
Effective Deflection (mm)	20	25	30	33	36
Natural Freq. (Hz)	3.55	3.10	2.90	2.77	2.63
Maximum OD (mm)	122	124	127	130	132
Weight (kg)	1.71				

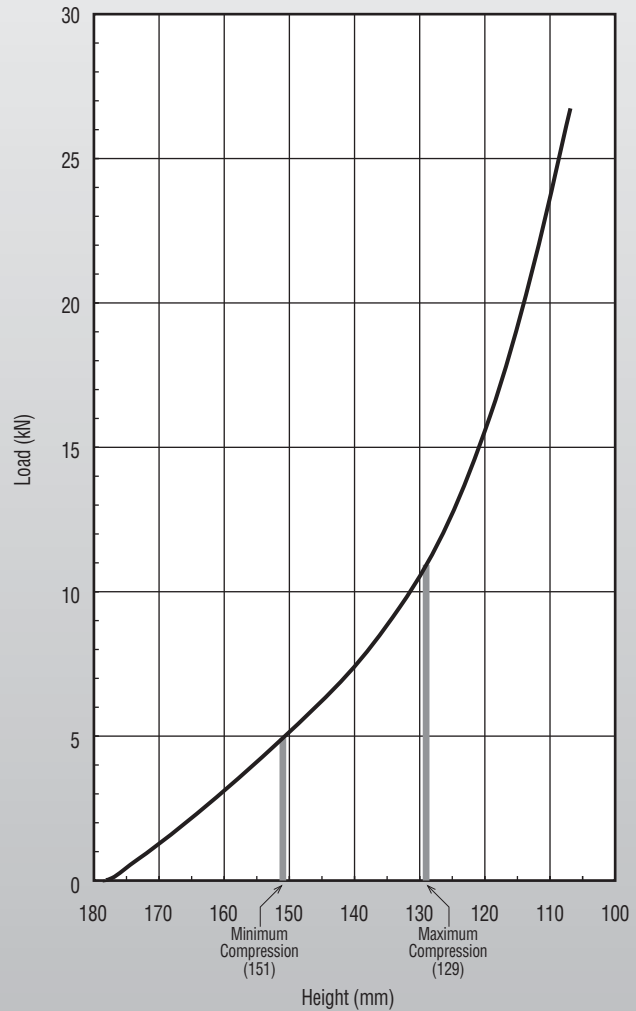
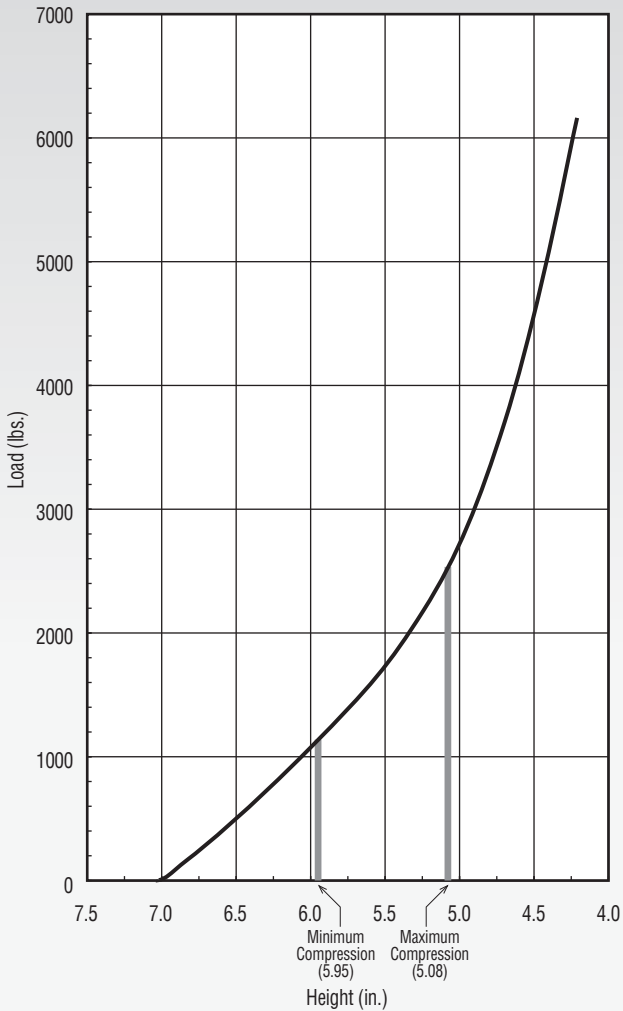
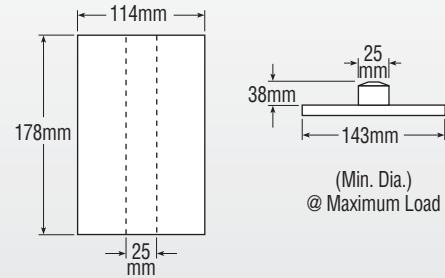

IMPERIAL

Compression (%)	15.0	20.0	22.5	25.0	27.5
Load (lbs.)	1400	1770	2100	2480	2860
Height (in.)	5.95	5.6	5.4	5.3	5.1
Rate (lbs./in.)	1743	1886	1998	2103	2203
Effective Deflection (in.)	0.8	0.9	1.1	1.2	1.3
Natural Freq. (CPM)	210	194	183	173	165
Maximum OD (in.)	5.2	5.4	5.5	5.6	5.7
Weight (lbs.)	4.78				

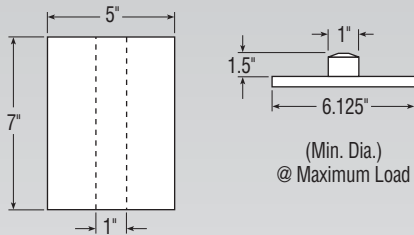

METRIC

Compression (%)	15.0	20.0	22.5	25.0	27.5
Load (kN)	6.22	7.87	9.33	11.02	12.71
Height (mm)	151	142	137	135	129
Rate (kN/m)	305	330	350	368	385
Effective Deflection (mm)	20	23	28	30	33
Natural Freq. (Hz)	3.50	3.23	3.05	2.88	2.75
Maximum OD (mm)	132	137	140	142	145
Weight (kg)	2.18				

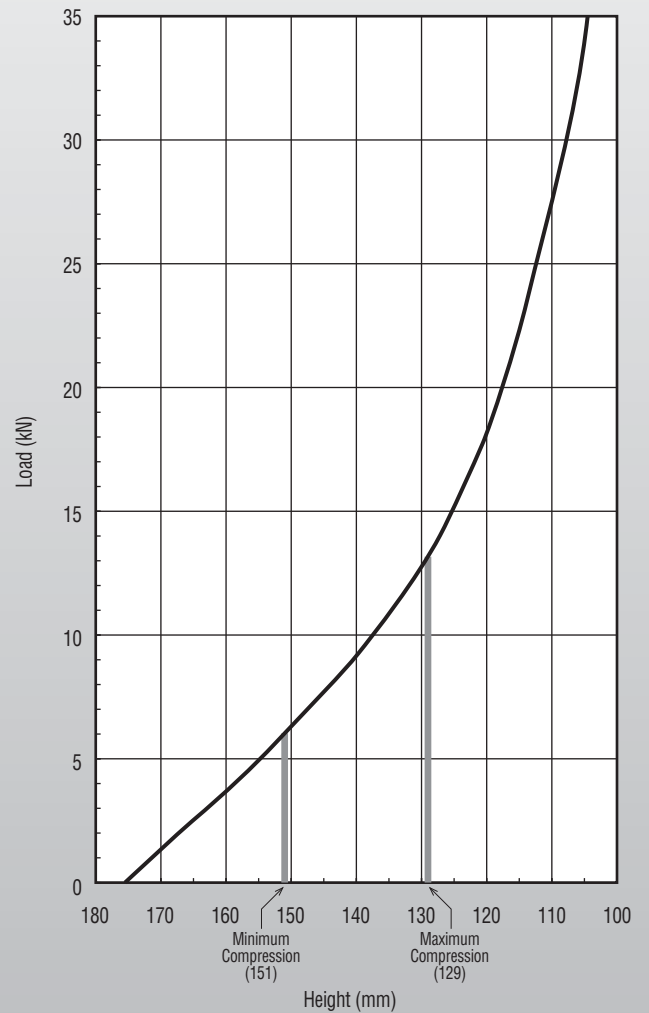
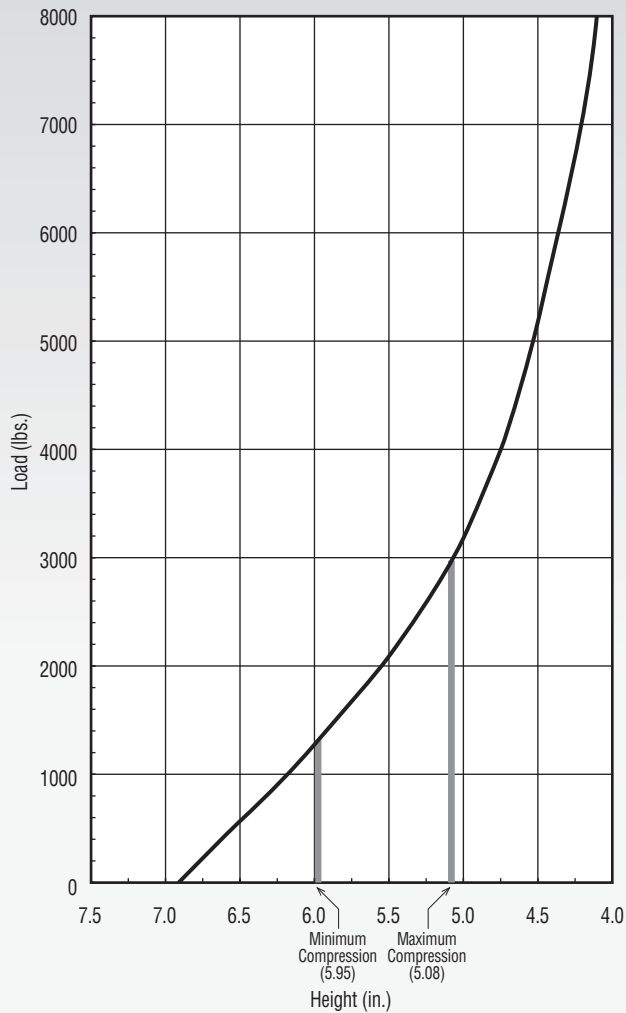
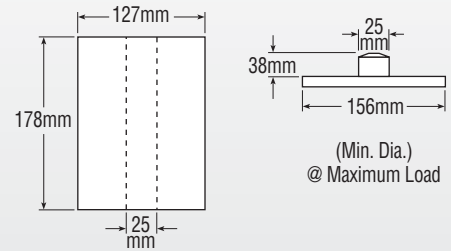

IMPERIAL

Compression (%)	15.0	20.0	22.5	25.0	27.5
Load (lbs.)	1400	1980	2340	2660	3080
Height (in.)	5.1	4.8	4.65	4.5	4.35
Rate (lbs./in.)	1720	2080	2360	2720	3200
Effective Deflection (in.)	0.81	0.95	0.99	0.98	0.96
Natural Freq. (CPM)	208	193	189	190	192
Maximum OD (in.)	6.5	6.6	6.7	6.8	6.9
Weight (lbs.)	4.42				

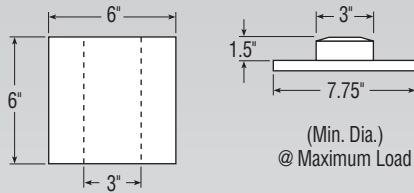

METRIC

Compression (%)	15.0	20.0	22.5	25.0	27.5
Load (kN)	6.22	8.80	10.40	11.82	13.69
Height (mm)	129	122	118	114	110
Rate (kN/m)	301	364	413	476	560
Effective Deflection (mm)	21	24	25	25	24
Natural Freq. (Hz)	3.47	3.21	3.15	3.17	3.19
Maximum OD (mm)	165	168	170	173	175
Weight (kg)	2.01				

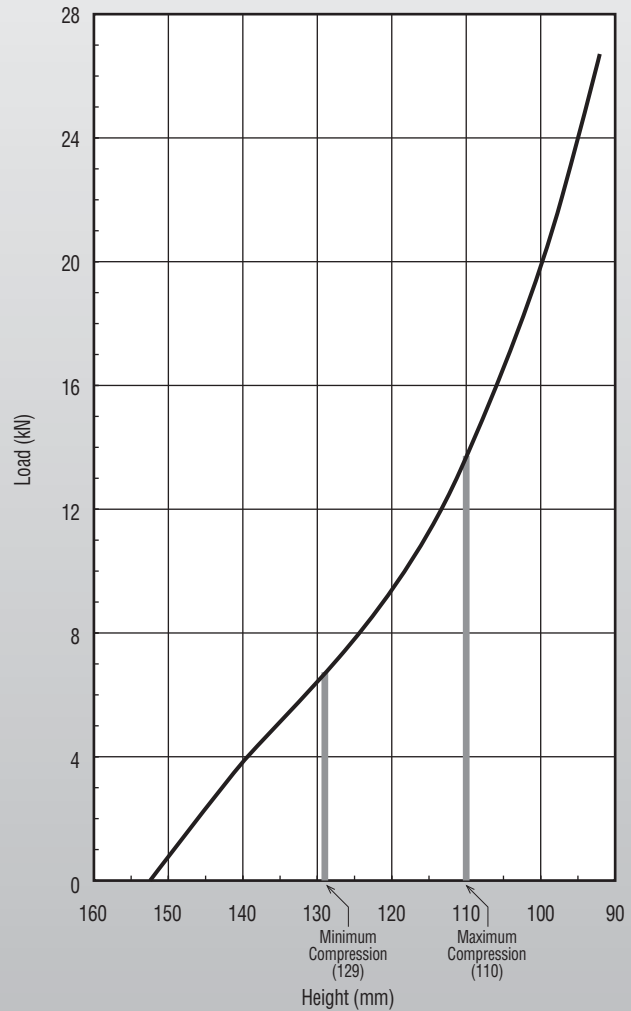
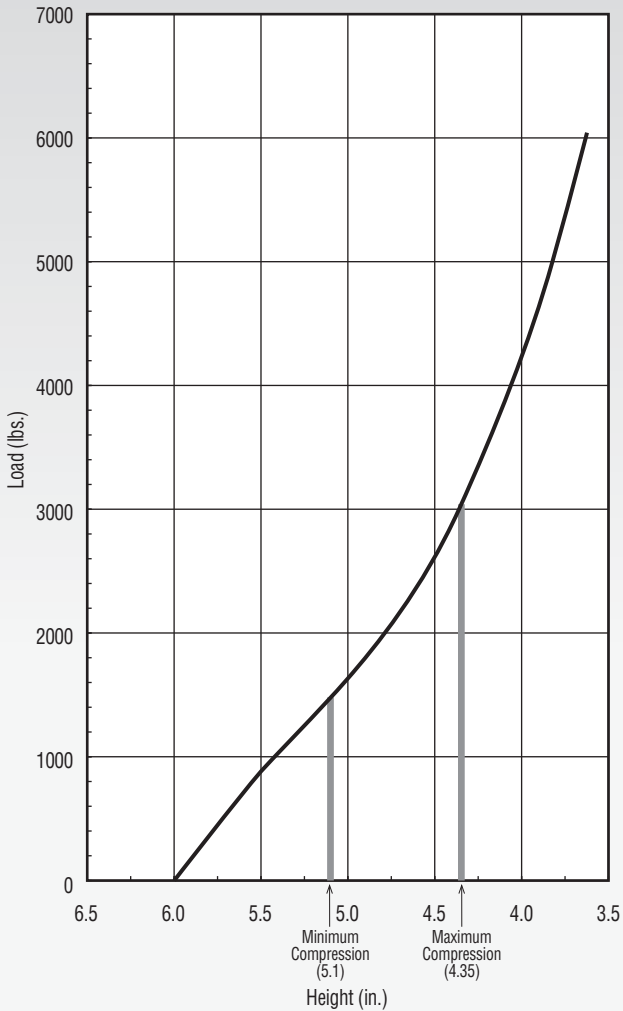
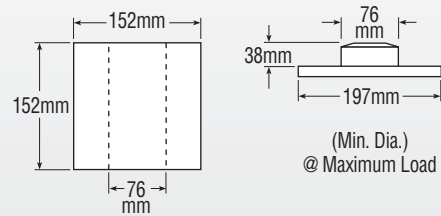

IMPERIAL

Compression (%)	15.0	20.0	22.5	25.0	27.5
Load (lbs.)	1530	2220	2590	2970	3350
Height (in.)	6.8	6.4	6.2	6.0	5.8
Rate (lbs./in.)	1652	1798	1862	1921	1976
Effective Deflection (in.)	0.9	1.2	1.4	1.5	1.7
Natural Freq. (CPM)	195	169	159	151	144
Maximum OD (in.)	6.9	7.1	7.2	7.3	7.5
Weight (lbs.)	7.29				

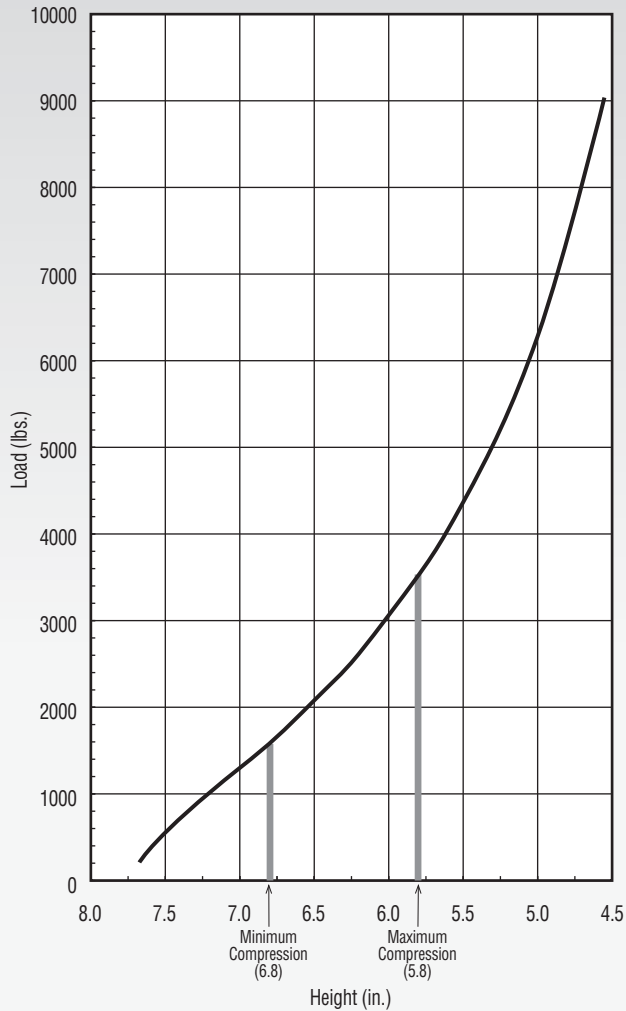
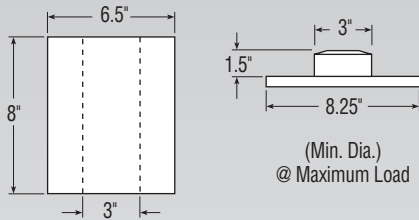

METRIC

Compression (%)	15.0	20.0	22.5	25.0	27.5
Load (kN)	6.80	9.87	11.51	13.20	14.89
Height (mm)	173	163	157	152	147
Rate (kN/m)	289	315	326	336	346
Effective Deflection (mm)	23	30	36	38	43
Natural Freq. (Hz)	3.25	2.82	2.65	2.52	2.40
Maximum OD (mm)	175	180	183	185	191
Weight (kg)	3.32				

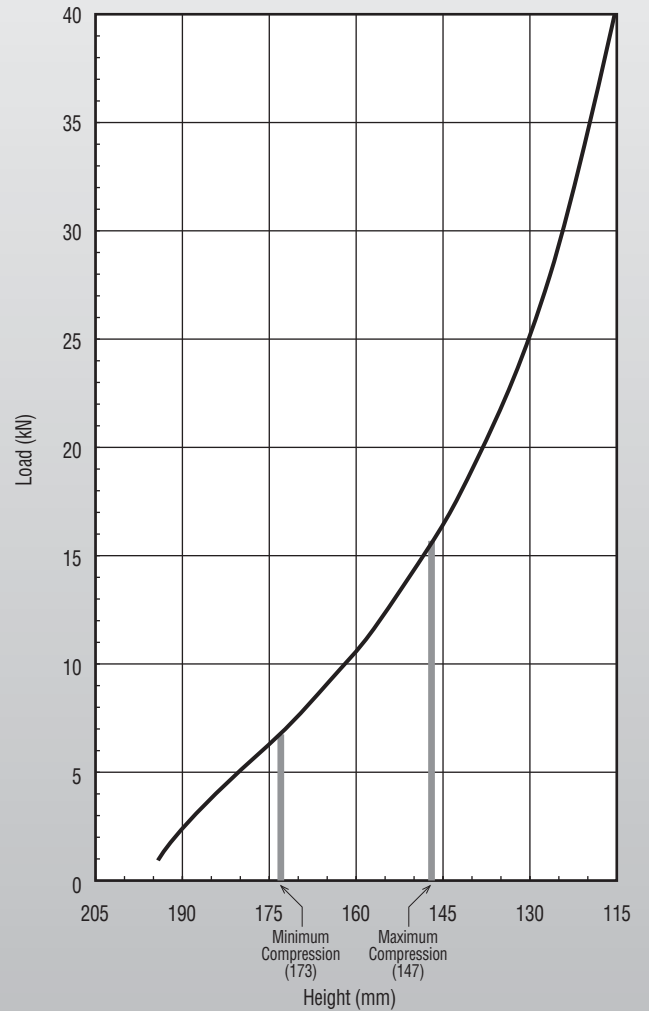
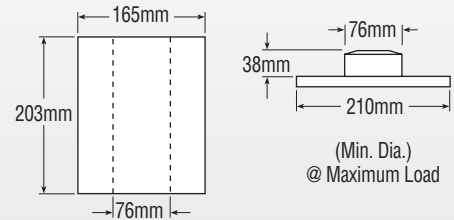

IMPERIAL

Compression (%)	15.0	20.0	22.5	25.0	27.5
Load (lbs.)	1540	2100	2460	2790	3280
Height (in.)	5.95	5.6	5.425	5.25	5.075
Rate (lbs./in.)	1440	1720	2110	2490	3040
Effective Deflection (in.)	1.07	1.22	1.17	1.12	1.08
Natural Freq. (GPM)	182	170	174	178	181
Maximum OD (in.)	5.8	6.0	6.1	6.2	6.3
Weight (lbs.)	5.07				

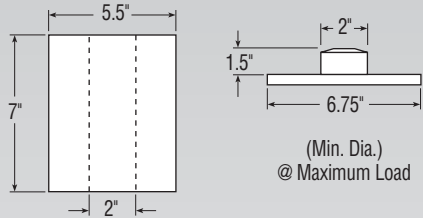

METRIC

Compression (%)	15.0	20.0	22.5	25.0	27.5
Load (kN)	6.84	9.33	10.93	12.40	14.58
Height (mm)	151	142	138	133	129
Rate (kN/m)	252	301	369	436	532
Effective Deflection (mm)	27	31	30	28	27
Natural Freq. (Hz)	3.03	2.84	2.90	2.96	3.02
Maximum OD (mm)	147	152	155	157	160
Weight (kg)	2.31				

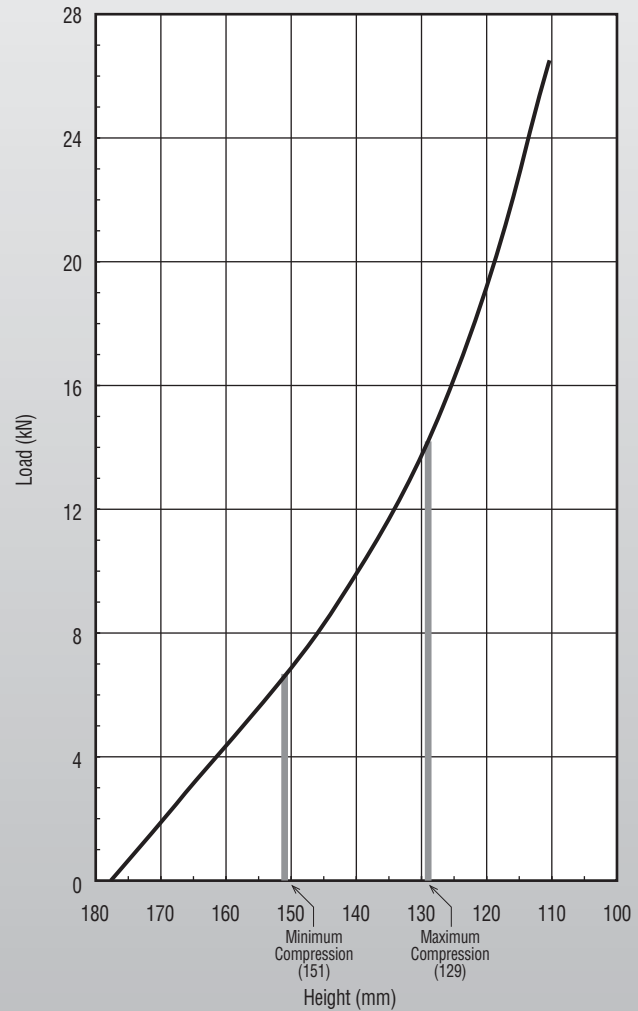
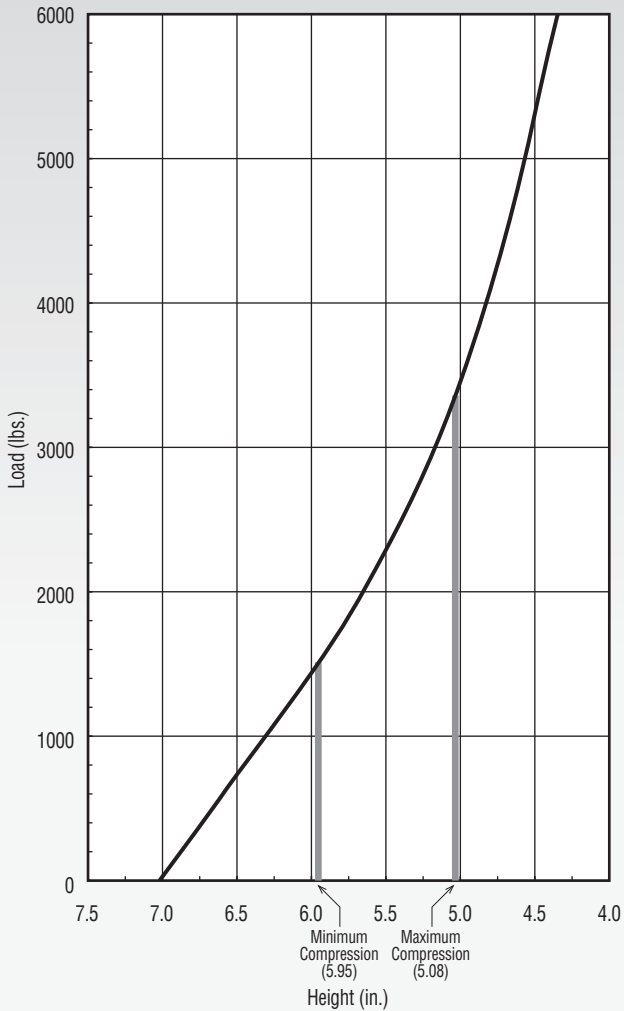
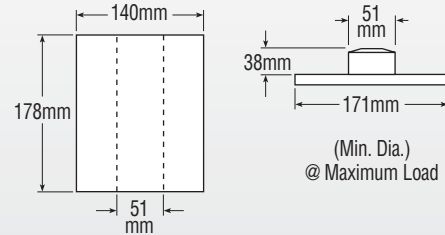

IMPERIAL

Compression (%)	15.0	20.0	22.5	25.0	27.5
Load (lbs.)	1965	2610	3070	3550	4050
Height (in.)	5.1	4.8	4.7	4.5	4.4
Rate (lbs./in.)	2684	2985	3118	3242	3359
Effective Deflection (in.)	0.7	0.9	1.0	1.1	1.2
Natural Freq. (CPM)	220	201	190	180	171
Maximum OD (in.)	6.4	6.5	6.6	6.7	6.9
Weight (lbs.)	5.78				

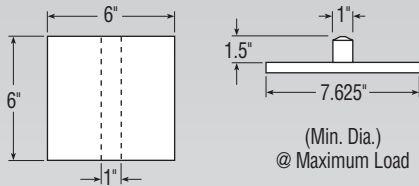

METRIC

Compression (%)	15.0	20.0	22.5	25.0	27.5
Load (kN)	8.73	11.60	13.64	15.78	18.00
Height (mm)	130	122	119	114	110
Rate (kN/m)	470	522	546	567	588
Effective Deflection (mm)	18	23	25	28	30
Natural Freq. (Hz)	3.66	3.35	3.17	3.00	2.85
Maximum OD (mm)	163	165	168	170	175
Weight (kg)	2.63				

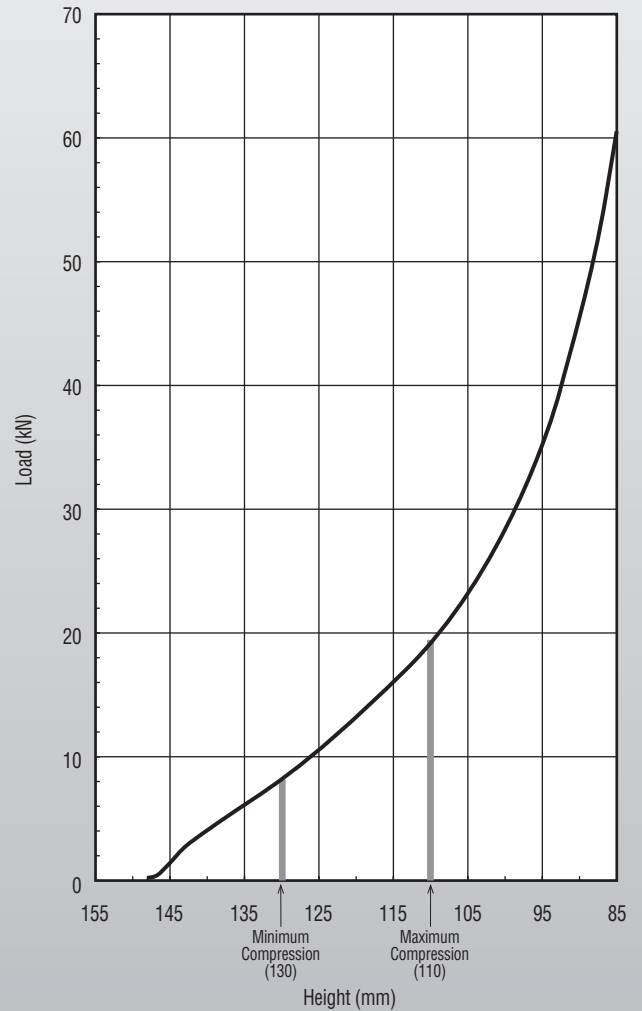
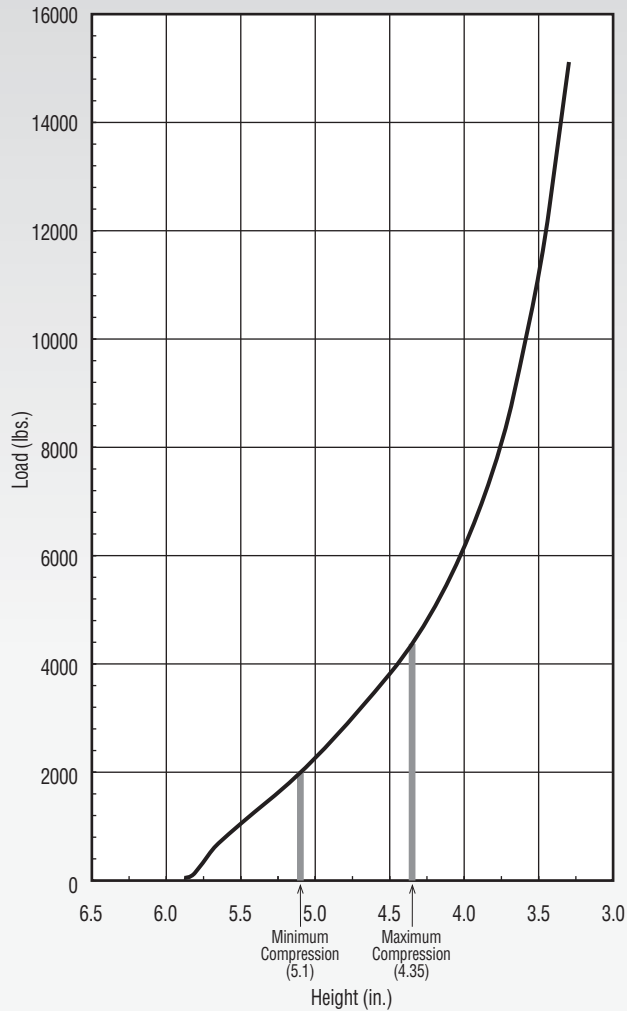
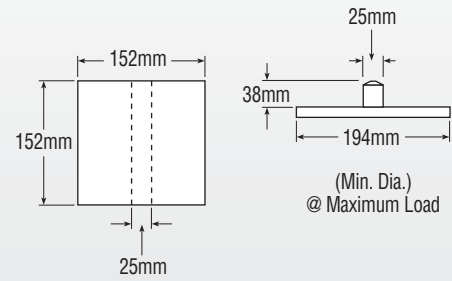

IMPERIAL

Compression (%)	15.0	20.0	22.5	25.0	27.5
Load (lbs.)	1990	2810	3280	3800	4400
Height (in.)	6.8	6.4	6.2	6.0	5.8
Rate (lbs./in.)	1946	2213	2464	2792	3198
Effective Deflection (in.)	1.0	1.3	1.3	1.4	1.4
Natural Freq. (CPM)	186	167	163	161	160
Maximum OD (in.)	6.9	7.1	7.2	7.3	7.4
Weight (lbs.)	8.48				

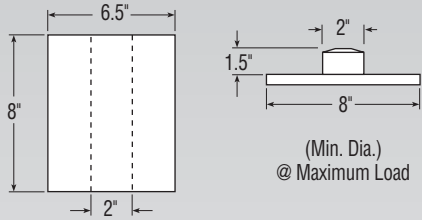

METRIC

Compression (%)	15.0	20.0	22.5	25.0	27.5
Load (kN)	8.84	12.49	14.58	16.89	19.56
Height (mm)	173	163	157	152	147
Rate (kg./cm.)	341	387	431	489	560
Effective Deflection (mm)	25	33	33	36	36
Natural Freq. (Hz)	3.10	2.78	2.72	2.68	2.67
Maximum OD (mm)	175	180	183	185	188
Weight (kg)	3.86				

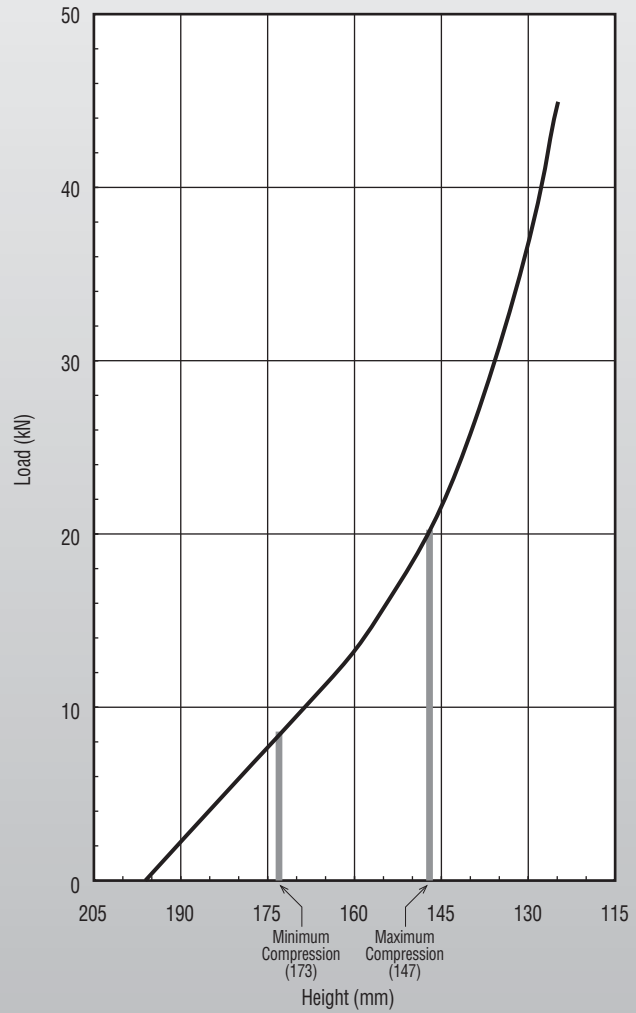
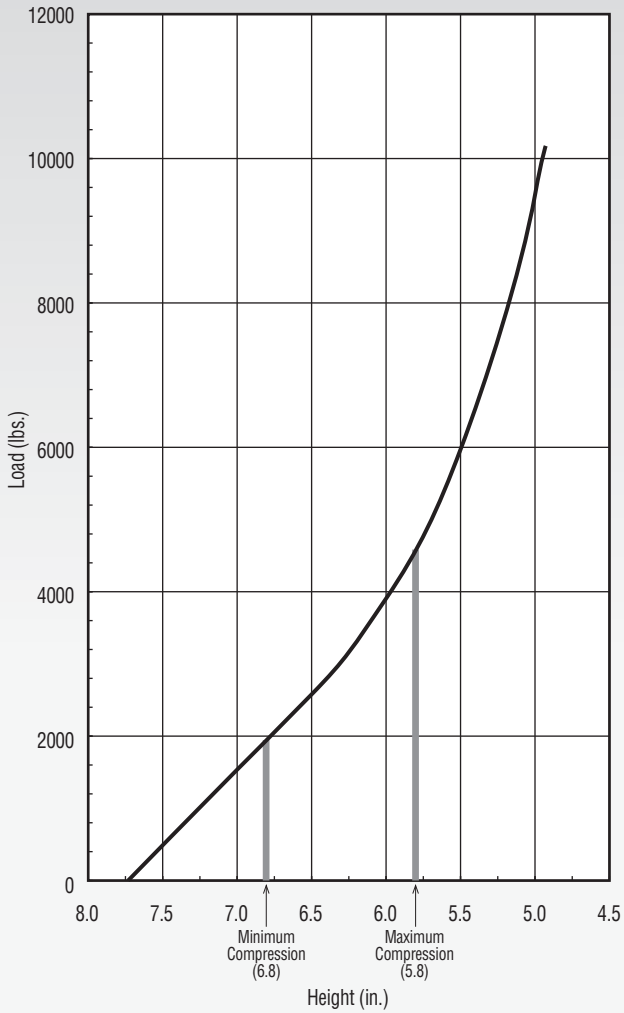
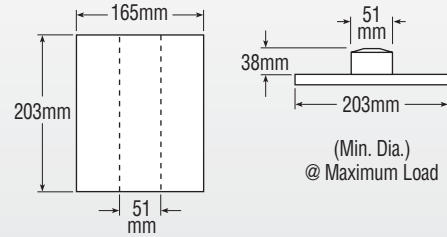

IMPERIAL

Compression (%)	15.0	20.0	22.5	25.0	27.5
Load (lbs.)	2180	3060	3650	4100	4670
Height (in.)	6.8	6.4	6.2	6.0	5.8
Rate (lbs./in.)	2273	2448	2524	2594	2558
Effective Deflection (in.)	1.0	1.2	1.4	1.6	1.8
Natural Freq. (CPM)	192.0	168.2	156.3	150.0	142.0
Maximum OD (in.)	6.4	6.6	6.7	6.8	7.0
Weight (lbs.)	7.84				

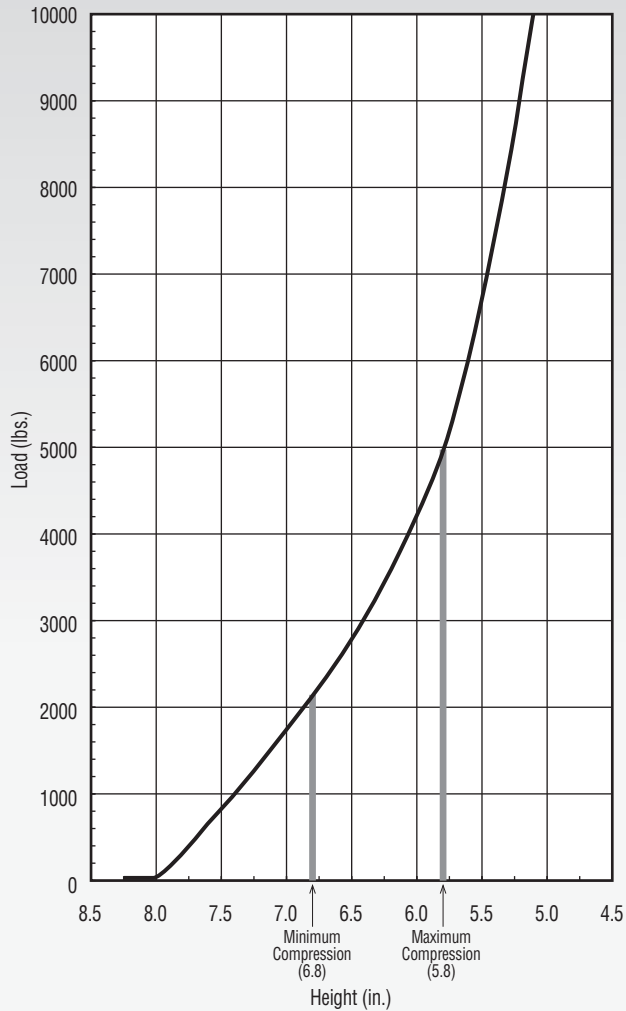
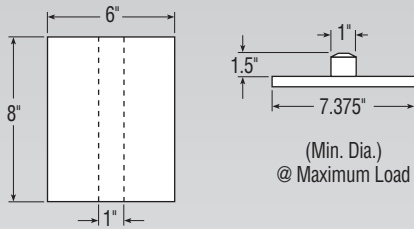

METRIC

Compression (%)	15.0	20.0	22.5	25.0	27.5
Load (kN)	9.69	13.60	16.22	18.22	20.76
Height (mm)	173	163	157	152	147
Rate (kN/m)	397	428	441	453	465
Effective Deflection (mm)	25	30	36	41	46
Natural Freq. (Hz)	3.20	2.80	2.61	2.50	2.37
Maximum OD (mm)	163	168	170	173	178
Weight (kg)	3.57				

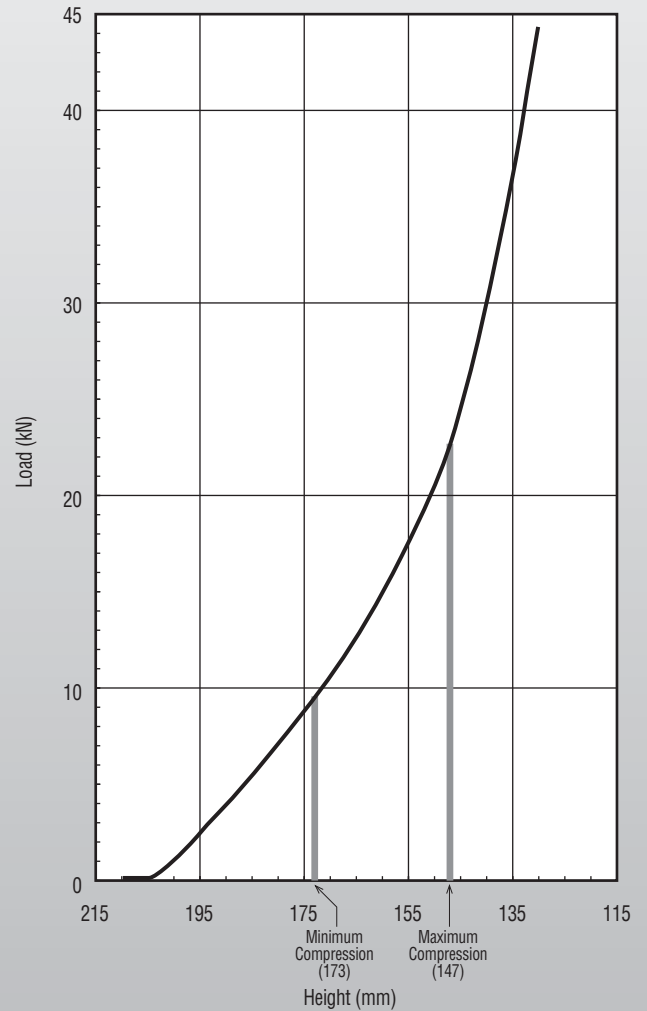
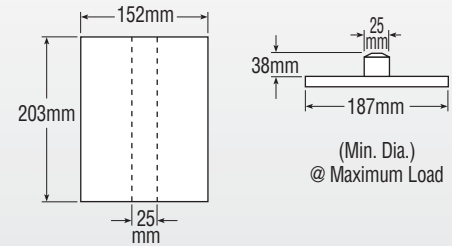

IMPERIAL

Compression (%)	15.0	20.0	22.5	25.0	27.5
Load (lbs.)	2300	3200	3800	4400	5150
Height (in.)	6.8	6.4	6.2	6.0	5.8
Rate (lbs./in.)	2100	2700	3000	3300	3900
Effective Deflection (in.)	1.10	1.19	1.27	1.33	1.32
Natural Freq. (CPM)	180	173	167	163	164
Maximum OD (in.)	8.0	8.2	8.3	8.4	8.6
Weight (lbs.)	10.00				

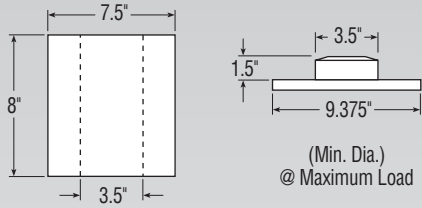

METRIC

Compression (%)	15.0	20.0	22.5	25.0	27.5
Load (kN)	10.22	14.22	16.89	19.56	22.89
Height (mm)	173	163	157	152	147
Rate (kN/m)	367	472	525	577	682
Effective Deflection (mm)	28	30	32	34	34
Natural Freq. (Hz)	2.99	2.88	2.78	2.71	2.73
Maximum OD (mm)	203	208	211	213	218
Weight (kg)	4.55				

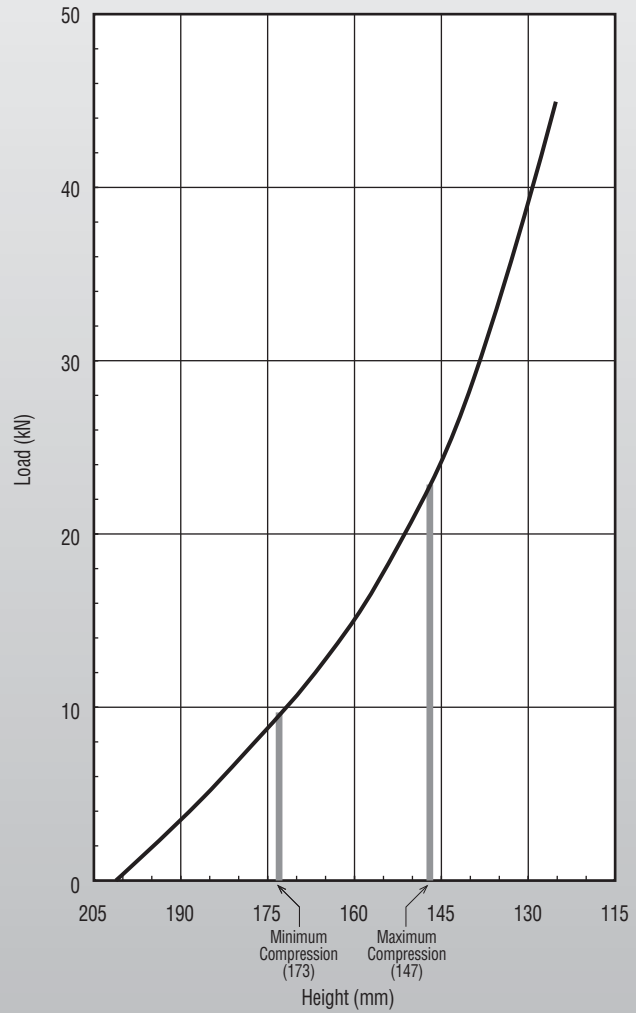
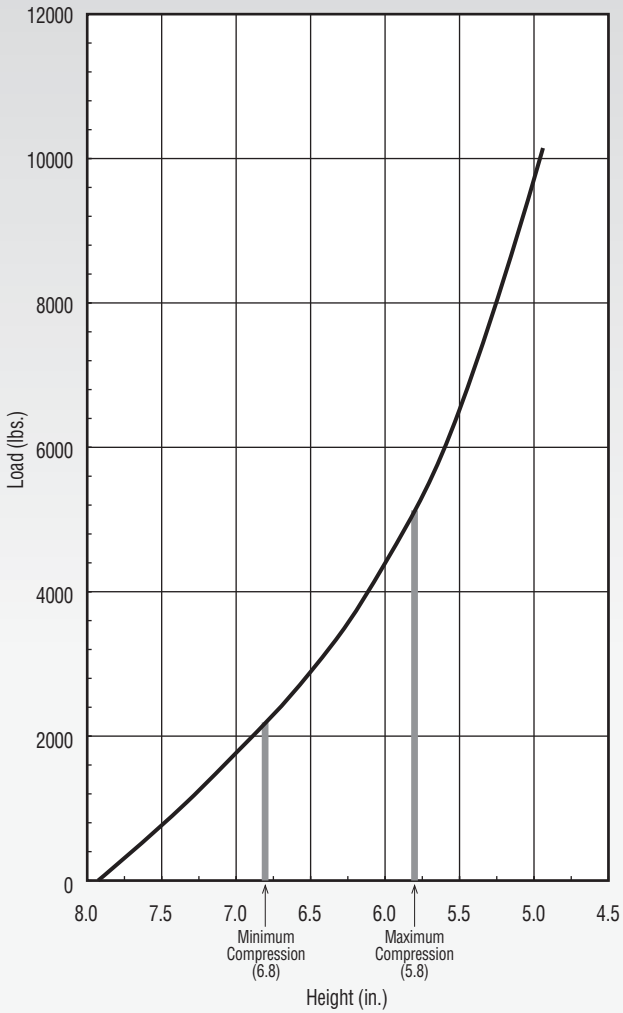
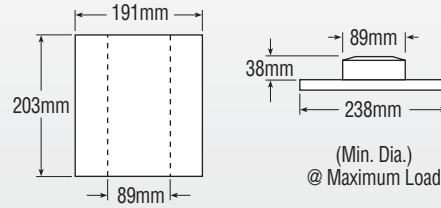

IMPERIAL

Compression (%)	15.0	20.0	22.5	25.0	27.5
Load (lbs.)	2300	3350	4000	4600	5300
Height (in.)	8.5	8.0	7.8	7.5	7.3
Rate (lbs./in.)	2000	2400	2500	2600	3100
Effective Deflection (in.)	1.15	1.40	1.60	1.77	1.71
Natural Freq. (CPM)	175	159	149	141	144
Maximum OD (in.)	7.9	8.1	8.3	8.4	8.6
Weight (lbs.)	12.58				

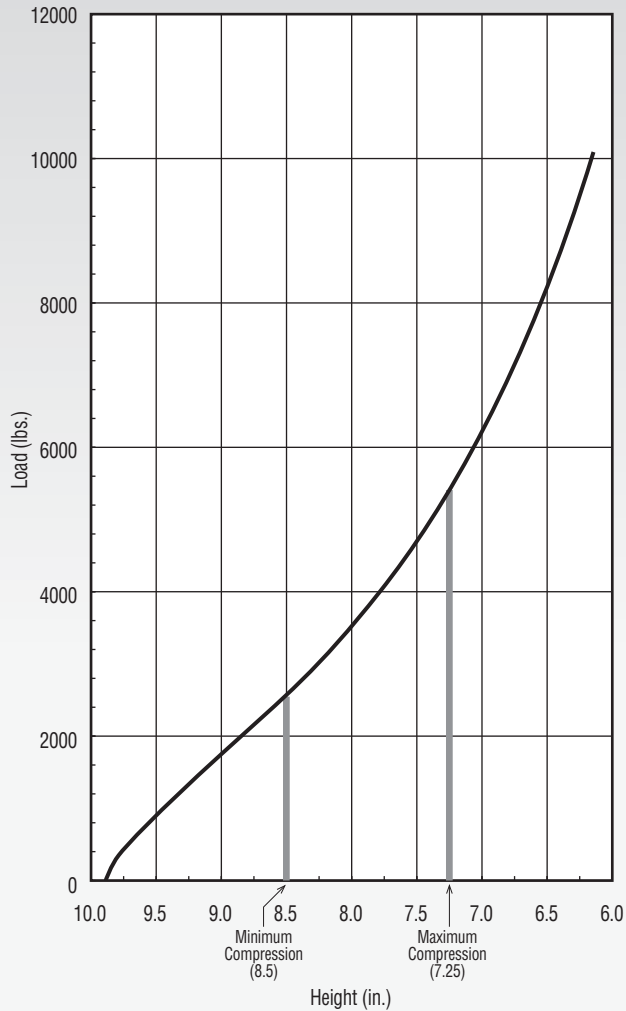
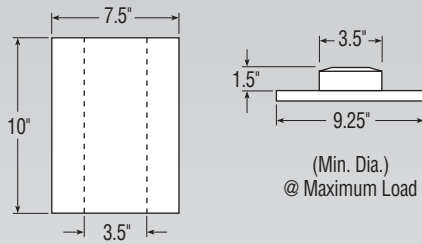

METRIC

Compression (%)	15.0	20.0	22.5	25.0	27.5
Load (kN)	10.22	14.89	17.78	20.44	23.56
Height (mm)	216	203	197	191	184
Rate (kN/m)	350	420	437	455	542
Effective Deflection (mm)	29	35	41	45	43
Natural Freq. (Hz)	2.92	2.65	2.48	2.36	2.40
Maximum OD (mm)	201	206	211	213	218
Weight (kg)	5.73				

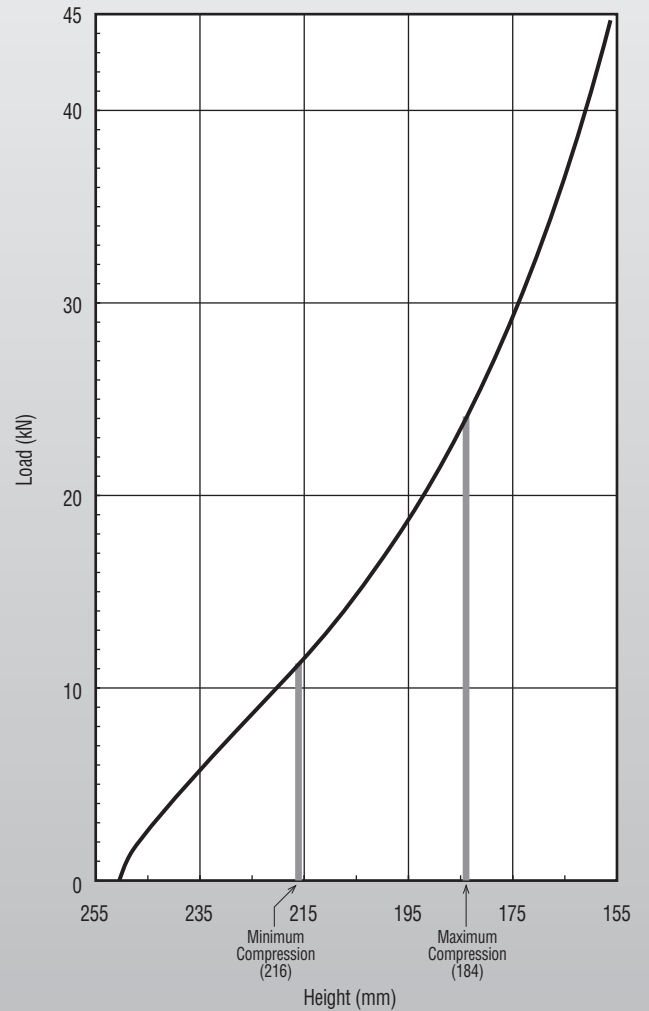
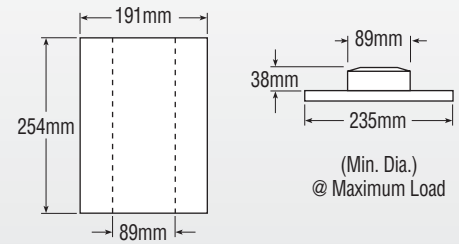

IMPERIAL

Compression (%)	15.0	20.0	22.5	25.0	27.5
Load (lbs.)	2700	3820	4540	5100	5870
Height (in.)	10.2	9.6	9.3	9.0	8.7
Rate (lbs./in.)	1903	2060	2128	2191	2249
Effective Deflection (in.)	1.4	1.9	2.1	2.3	2.6
Natural Freq. (CPM)	158	138	129	123	116
Maximum OD (in.)	8.5	8.7	8.9	9.0	9.3
Weight (lbs.)	16.94				

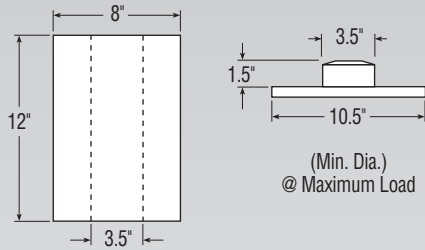

METRIC

Compression (%)	15.0	20.0	22.5	25.0	27.5
Load (kN)	12.00	16.98	20.18	22.67	26.09
Height (mm)	259	244	236	229	221
Rate (kN/m)	332	360	372	383	393
Effective Deflection (mm)	36	48	53	58	66
Natural Freq. (Hz)	2.63	2.30	2.15	2.05	1.93
Maximum OD (mm)	216	221	226	229	236
Weight (kg)	7.71				

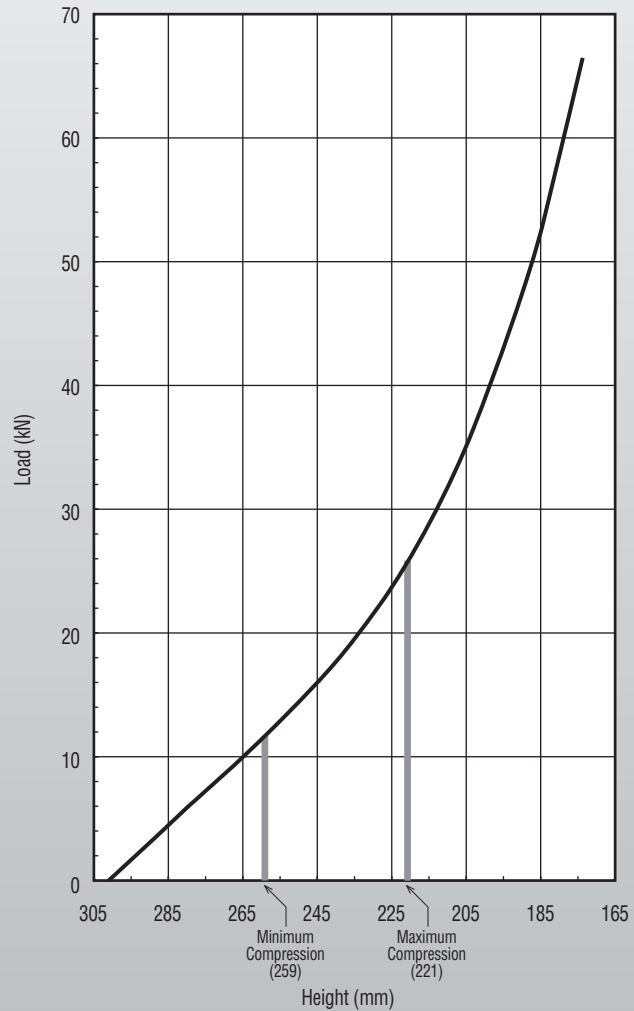
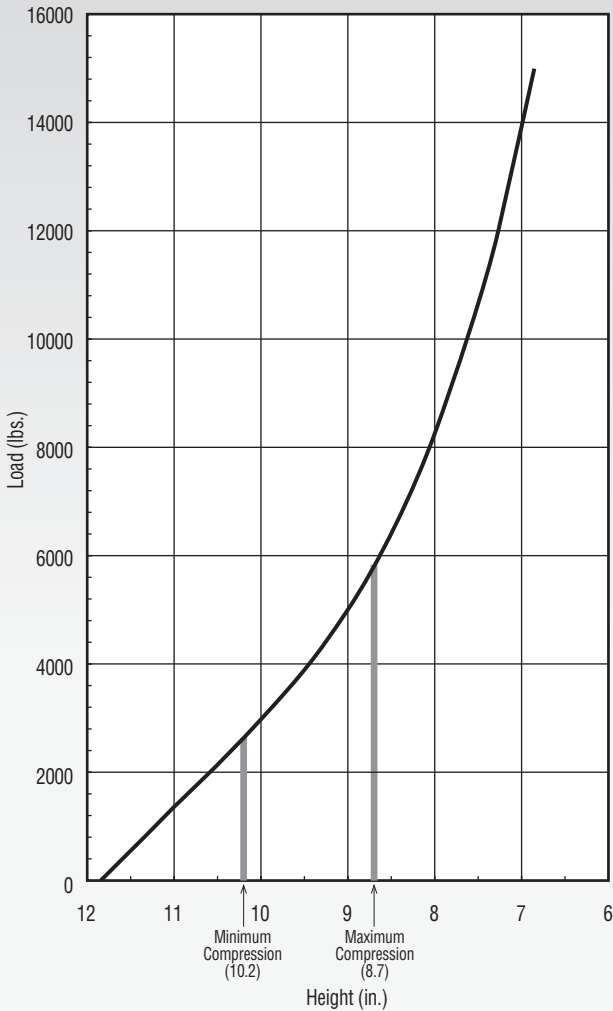
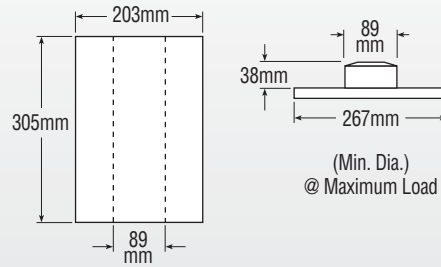

IMPERIAL

Compression (%)	15.0	20.0	22.5	25.0	27.5
Load (lbs.)	3800	5300	6200	7200	8400
Height (in.)	6.8	6.4	6.2	6.0	5.8
Rate (lbs./in.)	3508	4141	4727	5492	6436
Effective Deflection (in.)	1.1	1.3	1.3	1.3	1.3
Natural Freq. (CPM)	181	166	164	164	165
Maximum OD (in.)	8.2	8.5	8.7	9.0	9.3
Weight (lbs.)	13.52				

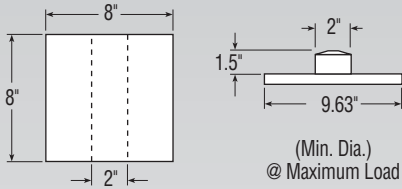

METRIC

Compression (%)	15.0	20.0	22.5	25.0	27.5
Load (kN)	16.89	23.58	27.56	32.00	37.33
Height (mm)	173	163	157	152	147
Rate (kN/m)	614	725	827	961	1126
Effective Deflection (mm)	28	33	33	33	33
Natural Freq. (Hz)	3.02	2.77	2.73	2.73	2.75
Maximum OD (mm)	208	216	221	229	236
Weight (kg)	6.16				

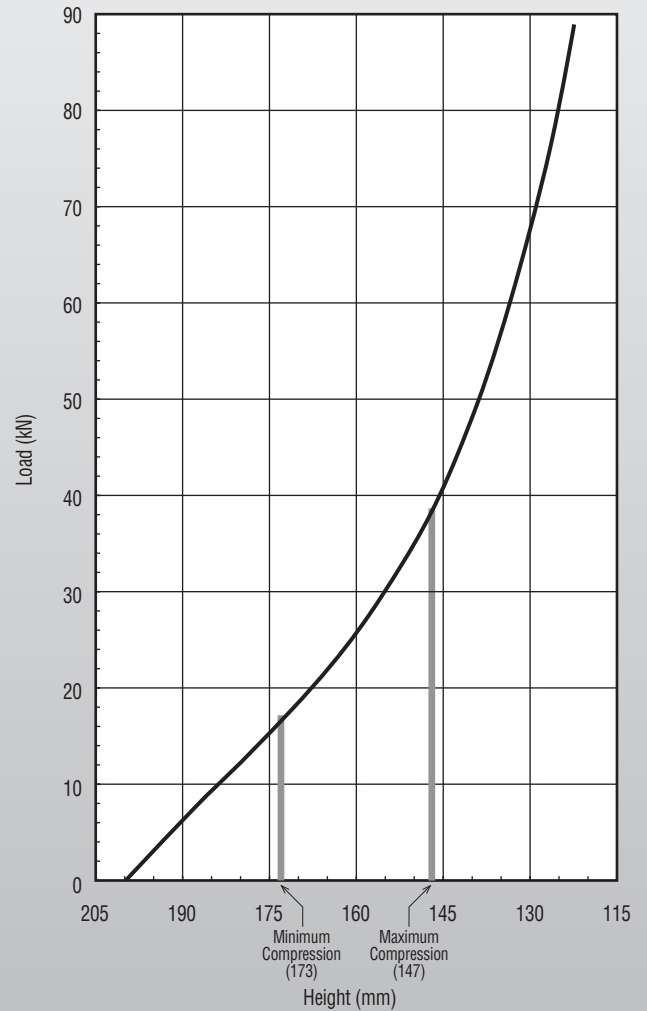
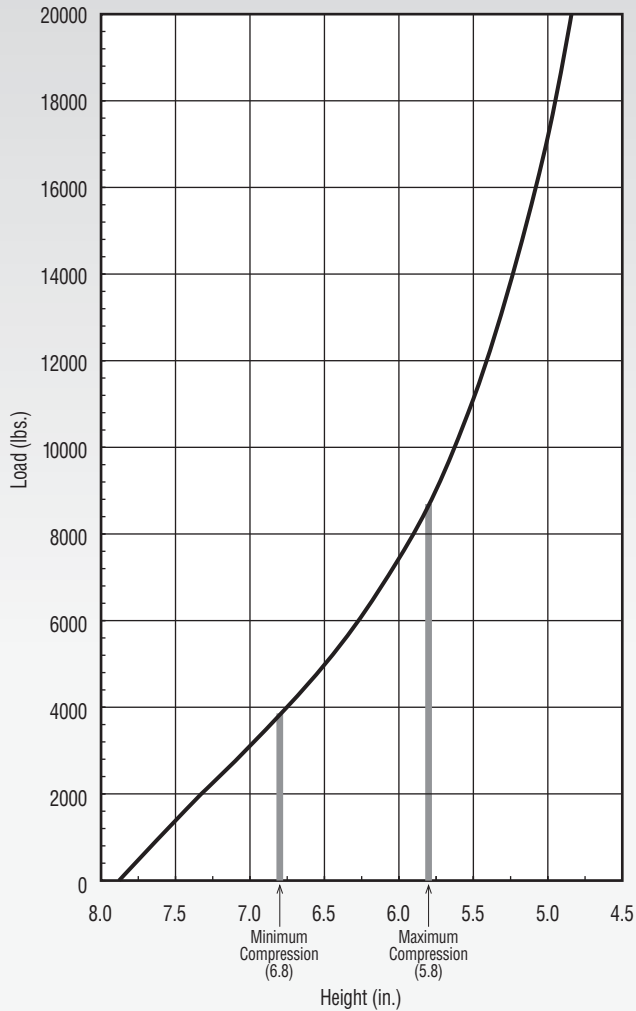
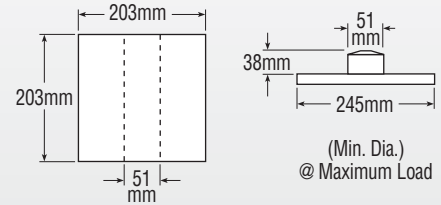

IMPERIAL

Compression (%)	15.0	20.0	22.5	25.0	27.5
Load (lbs.)	5200	7400	8600	10000	11400
Height (in.)	6.8	6.4	6.2	6.0	5.8
Rate (lbs./in.)	4893	5993	6486	6942	7359
Effective Deflection (in.)	1.1	1.2	1.3	1.4	1.5
Natural Freq. (CPM)	182	169	163	157	151
Maximum OD (in.)	9.50	9.78	9.90	10.08	10.24
Weight (lbs.)	16.88				

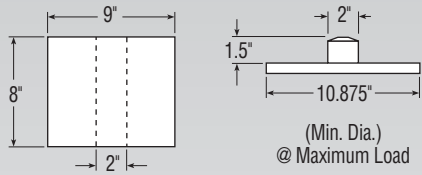

METRIC

Compression (%)	15.0	20.0	22.5	25.0	27.5
Load (kN)	23.11	32.89	38.22	44.44	50.67
Height (mm)	173	163	157	152	147
Rate (kN/m)	856	1048	1134	1214	1287
Effective Deflection (mm)	28	30	33	36	38
Natural Freq. (Hz)	3.03	2.82	2.72	2.62	2.52
Maximum OD (mm)	241	248	251	256	260
Weight (kg)	7.69				

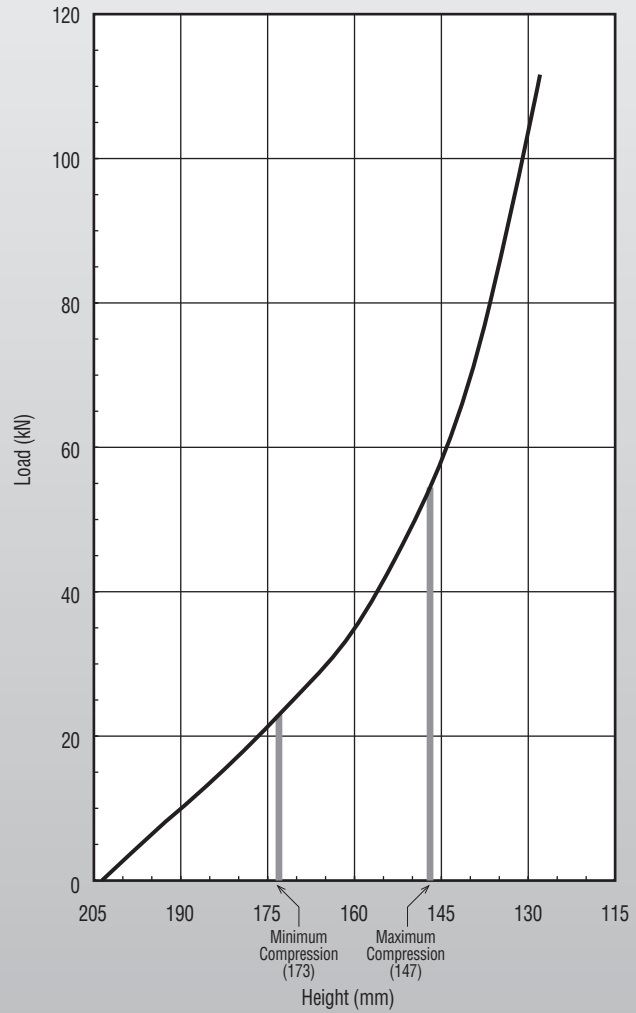
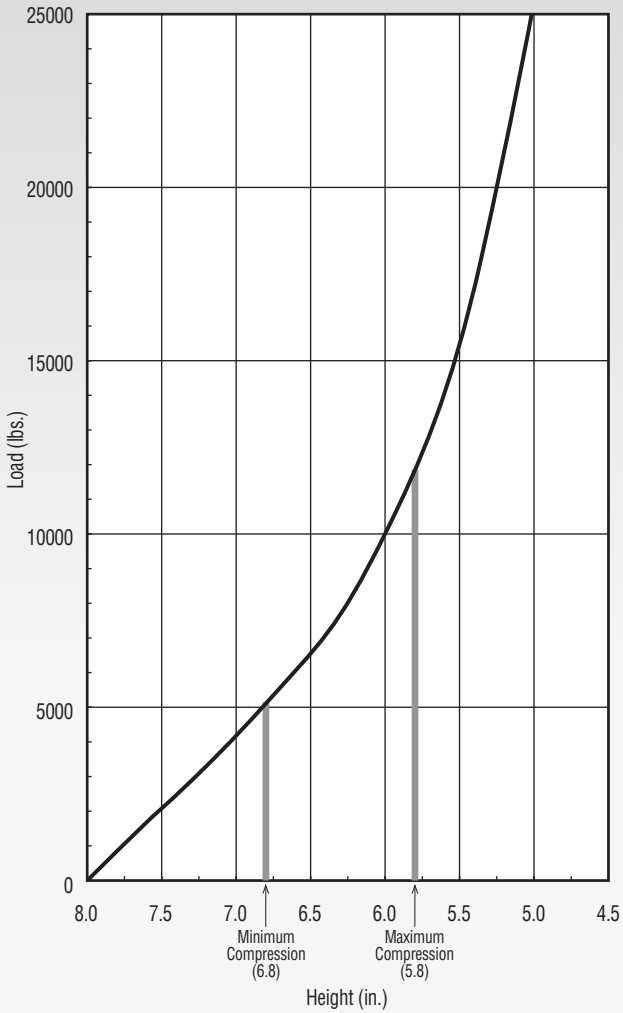
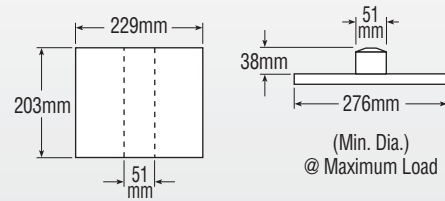

IMPERIAL

Compression (%)	15.0	20.0	22.5	25.0	27.5
Load (lbs.)	5500	7850	9150	10750	12250
Height (in.)	11.9	11.2	10.9	10.5	10.2
Rate (lbs./in.)	3422	3752	3897	4031	4156
Effective Deflection (in.)	1.6	2.1	2.3	2.7	2.9
Natural Freq. (CPM)	148	130	123	115	110
Maximum OD (in.)	12.7				
Weight (lbs.)	37.28				

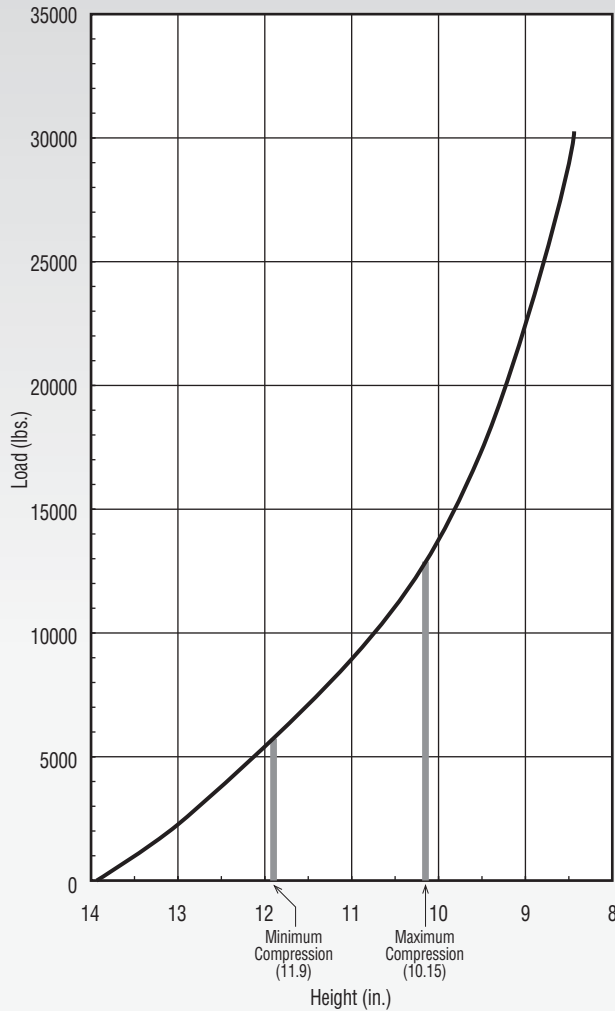
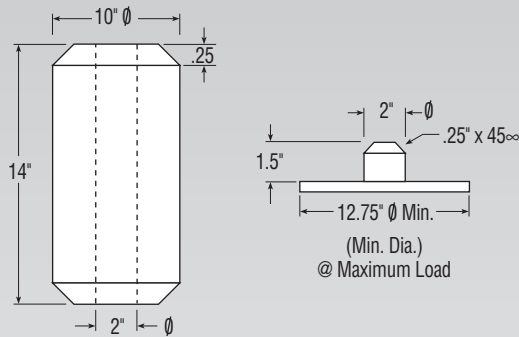

METRIC

Compression (%)	15.0	20.0	22.5	25.0	27.5
Load (kN)	24.44	34.89	40.67	47.78	54.44
Height (mm)	302	284	277	267	259
Rate (kN/m)	598	656	681	705	727
Effective Deflection (mm)	41	53	58	69	74
Natural Freq. (Hz)	2.47	2.17	2.05	1.92	1.83
Maximum OD (mm)	323				
Weight (kg)	16.98				

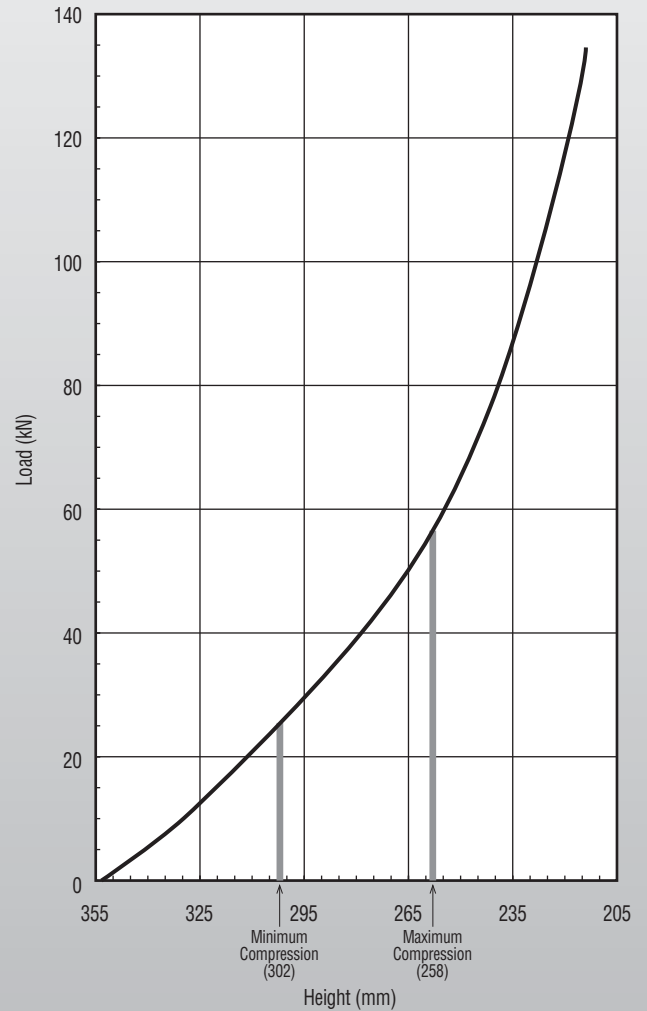
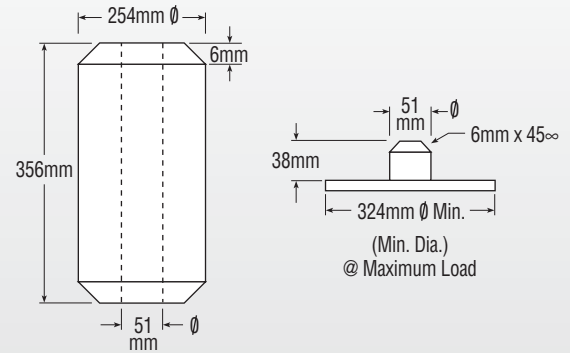

IMPERIAL

Compression (%)	15.0	20.0	22.5	25.0	27.5
Load (lbs.)	6600	9600	11200	13000	15000
Height (in.)	6.8	6.4	6.2	6.0	5.8
Rate (lbs./in.)	7409	7775	8440	9425	10731
Effective Deflection (in.)	0.9	1.2	1.3	1.4	1.4
Natural Freq. (CPM)	199	169	163	160	159
Maximum OD (in.)	12.6				
Weight (lbs.)	21.62				

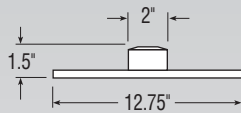
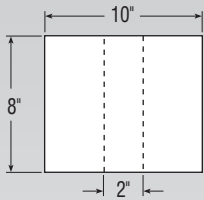

(Min. Dia.)
@ Maximum Load

METRIC

Compression (%)	15.0	20.0	22.5	25.0	27.5
Load (kN)	29.33	42.67	49.78	57.78	66.67
Height (mm)	173	163	157	152	147
Rate (kN/m)	1296	1360	1477	1649	1878
Effective Deflection (mm)	23	30	33	36	36
Natural Freq. (Hz)	3.32	2.82	2.72	2.67	2.65
Maximum OD (mm)	320				
Weight (kg)	9.84				

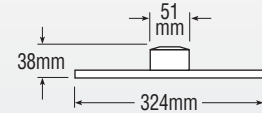
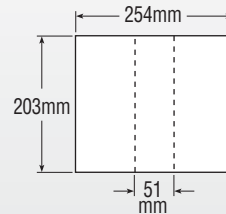

(Min. Dia.)
@ Maximum Load

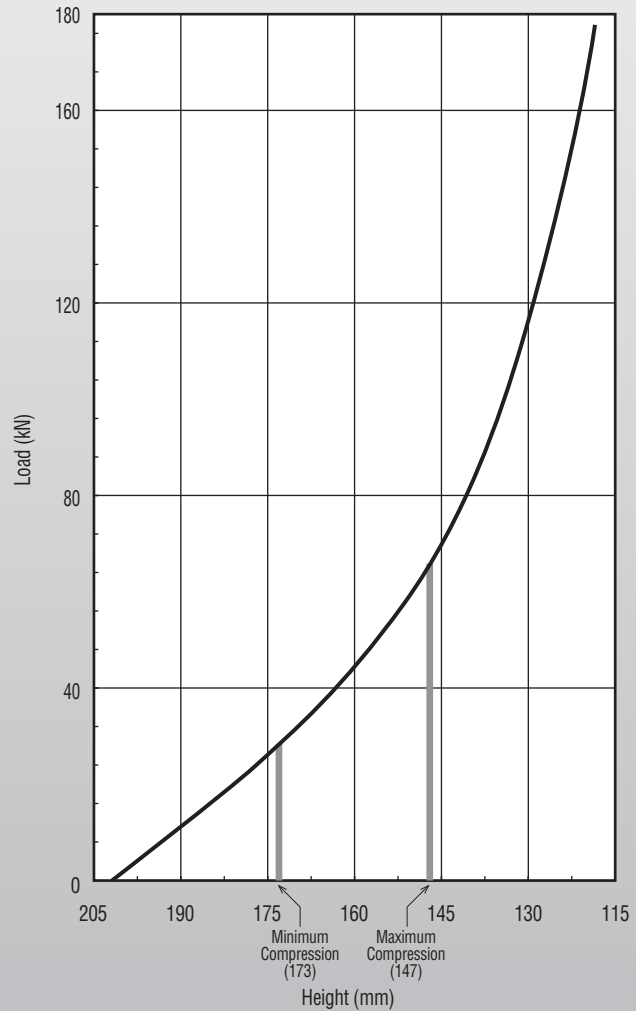
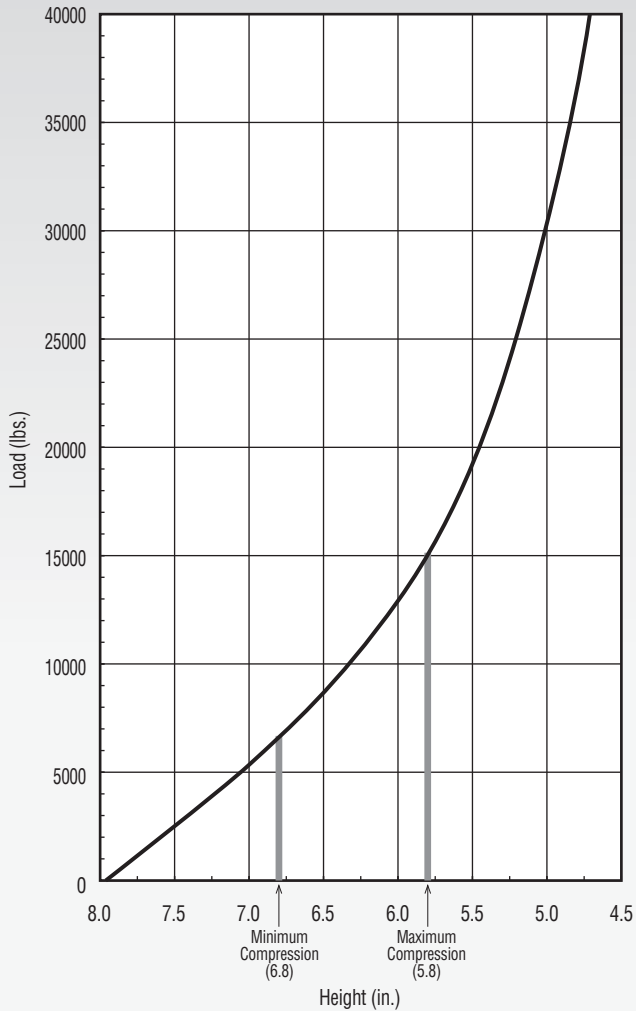

IMPERIAL

Compression (%)	15.0	20.0	22.5	25.0	27.5
Load (lbs.)	8200	11700	14000	16625	20000
Height (in.)	5.1	4.8	4.65	4.5	4.35
Rate (lbs./in.)	11200	13700	16600	20000	23600
Effective Deflection (in.)	0.73	0.85	0.84	0.83	0.85
Natural Freq. (CPM)	220	203	205	206	204
Maximum OD (in.)	13.7				
Weight (lbs.)	19.58				

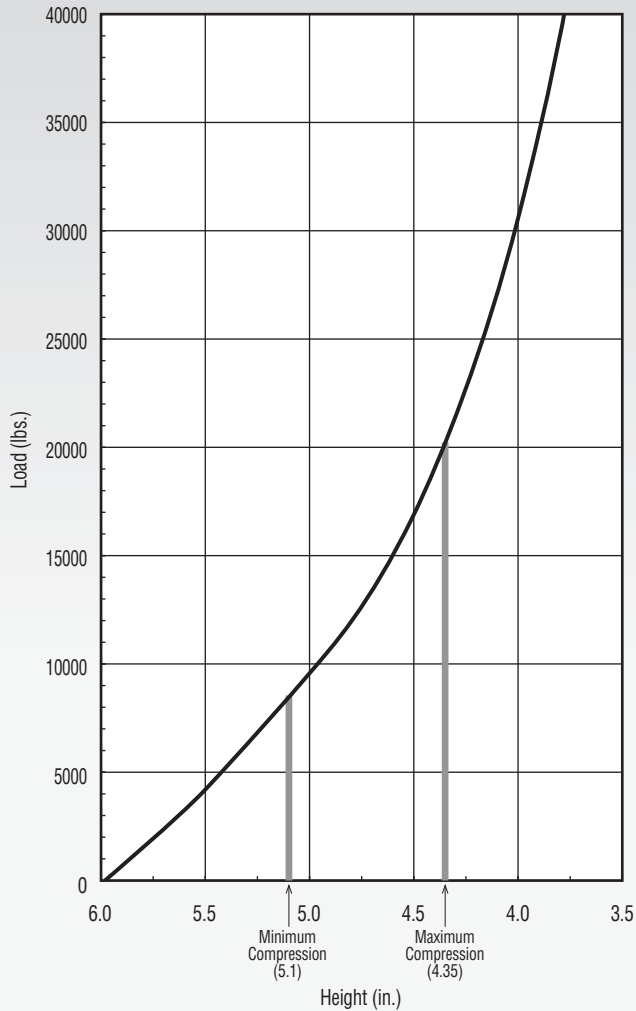
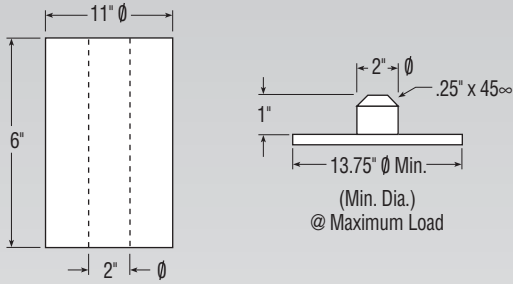

METRIC

Compression (%)	15.0	20.0	22.5	25.0	27.5
Load (kN)	36.44	52.00	62.22	73.89	88.89
Height (mm)	130	122	118	114	110
Rate (kN/m)	1960	2397	2905	3500	4129
Effective Deflection (mm)	19	22	21	21	22
Natural Freq. (Hz)	3.66	3.39	3.41	3.44	3.40
Maximum OD (mm)	348				
Weight (kg)	8.92				

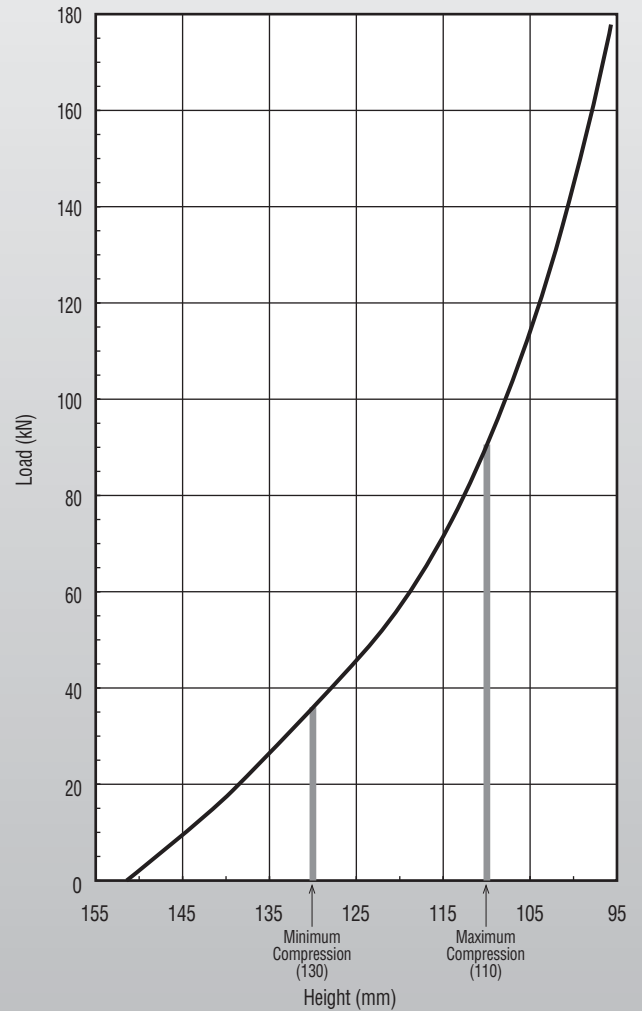
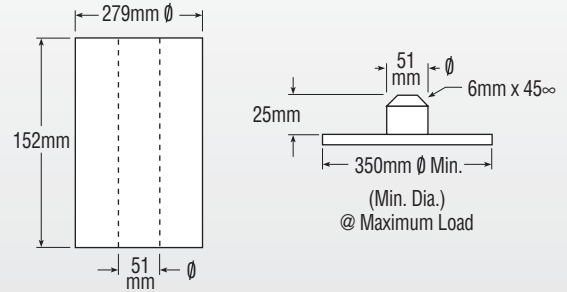

IMPERIAL

Compression (%)	15.0	20.0	22.5	25.0	27.5
Load (lbs.)	8300	12000	14000	16200	19600
Height (in.)	6.8	6.4	6.2	6.0	5.8
Rate (lbs./in.)	8917	9690	10025	10335	10623
Effective Deflection (in.)	0.9	1.2	1.4	1.6	1.9
Natural Freq. (CPM)	195	169	159	150	138
Maximum OD (in.)	13.4				
Weight (lbs.)	26.60				

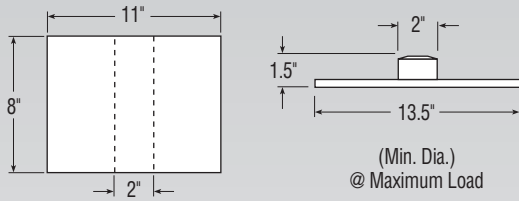

METRIC

Compression (%)	15.0	20.0	22.5	25.0	27.5
Load (kN)	36.89	53.33	62.22	72.00	87.11
Height (mm)	173	163	157	152	147
Rate (kN/m)	1560	1696	1754	1808	1859
Effective Deflection (mm)	23	30	36	41	47
Natural Freq. (Hz)	3.25	2.82	2.65	2.50	2.31
Maximum OD (mm)	340				
Weight (kg)	12.11				

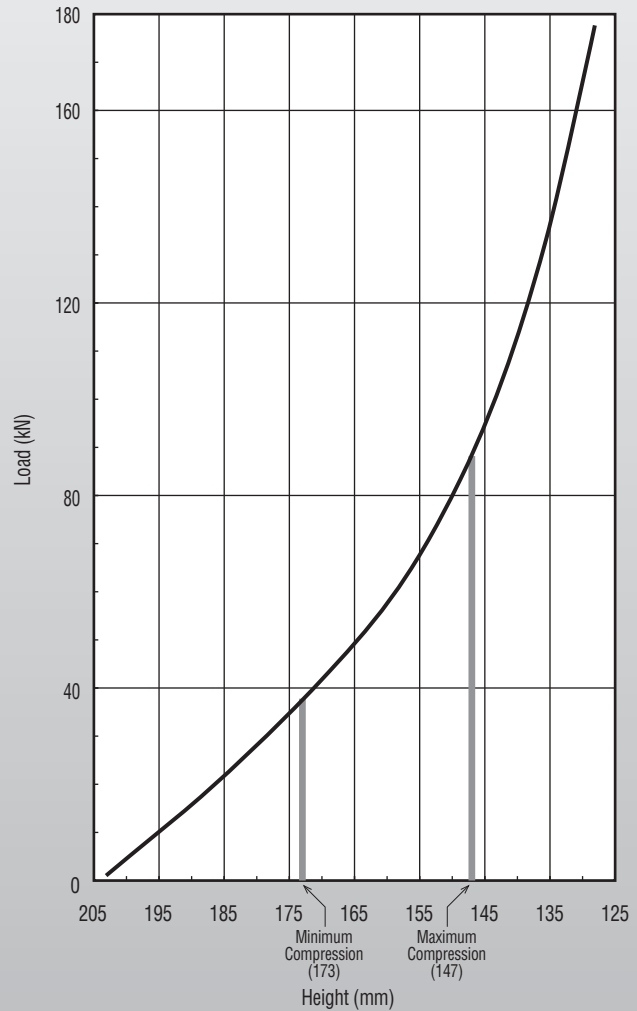
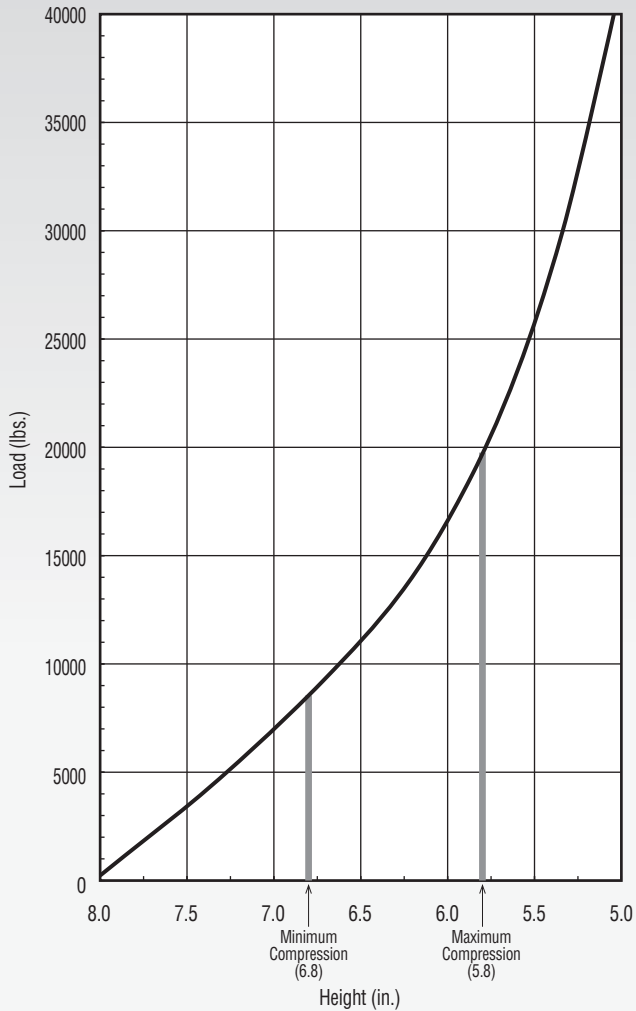
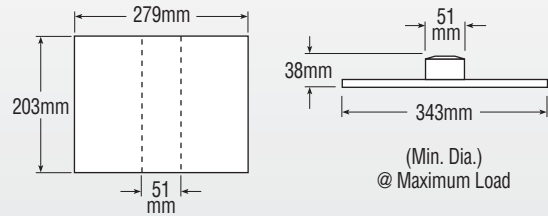

IMPERIAL

Extension (%)	110.0	120.0	130.0
Load (lbs.)	125	200	270
Length (in.)	7.15	7.8	8.45
Rate (lbs./in.)	120	80	120
Effective Deflection (in.)	1.04	2.5	2.25
Natural Freq. (CPM)	184	119	125
Weight (lbs.)	0.57		

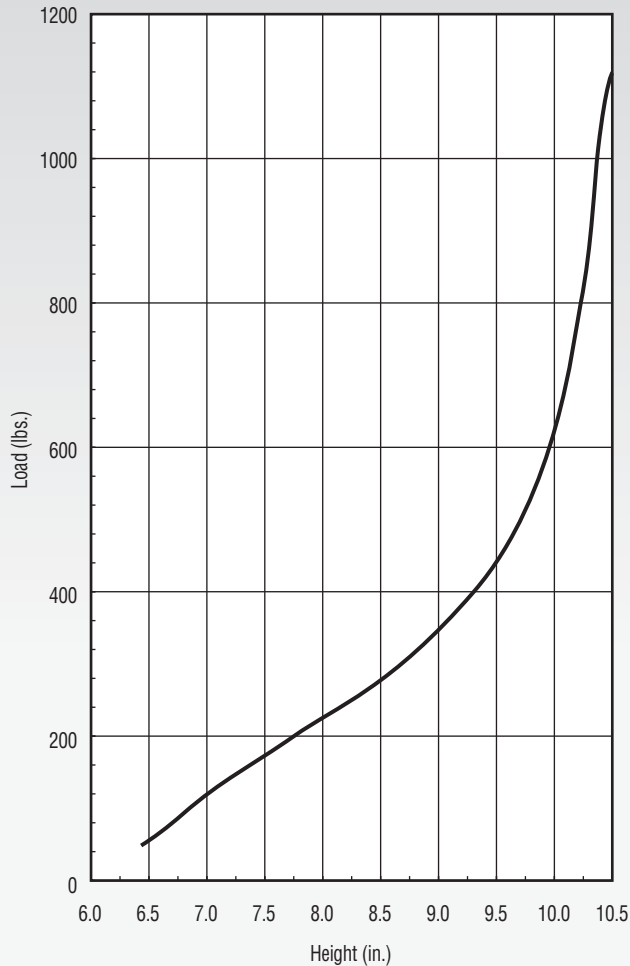
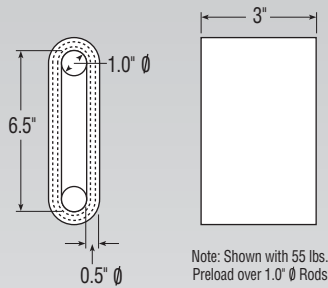

METRIC

Extension (%)	110.0	120.0	130.0
Load (kN)	0.56	0.89	1.2
Length (mm)	182	198	215
Rate (kN/m)	21	14	21
Effective Deflection (mm)	26	64	57
Natural Freq. (Hz)	3.07	1.98	2.09
Weight (lbs.)	0.26		

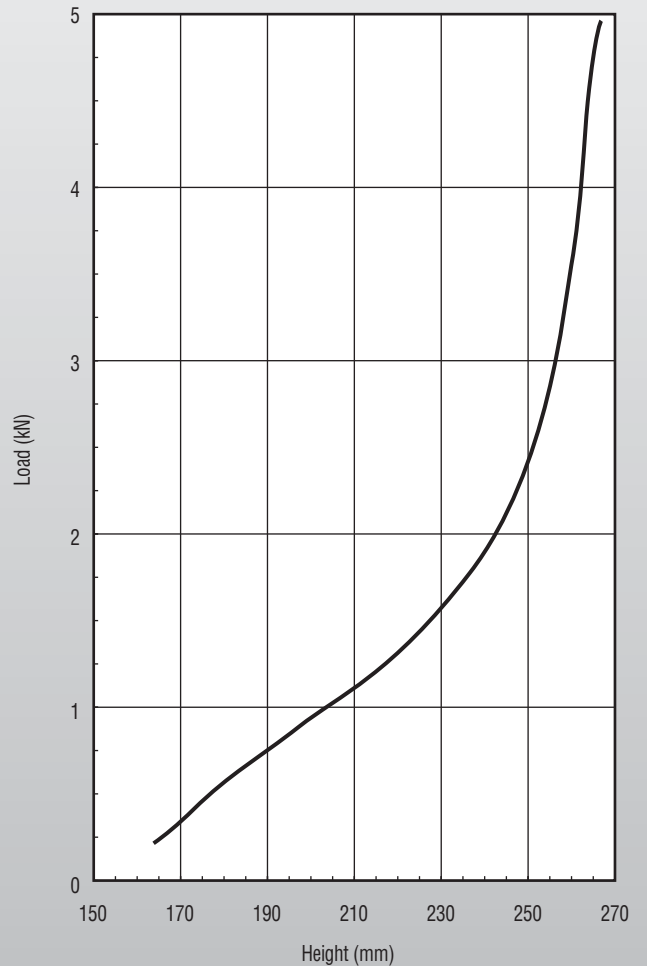
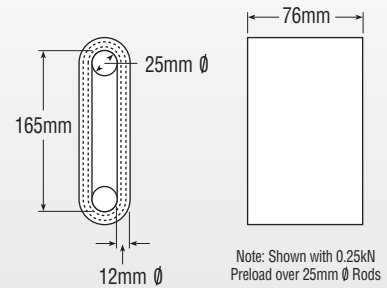

IMPERIAL

Extension (%)	110.0	120.0	130.0
Load (lbs.)	175	275	375
Length (in.)	15.4	16.8	18.2
Rate (lbs./in.)	70	74	94
Effective Deflection (in.)	2.5	3.72	3.99
Natural Freq. (CPM)	119	98	94
Weight (lbs.)	1.38		

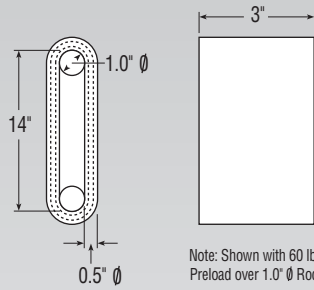

METRIC

Extension (%)	110.0	120.0	130.0
Load (kN)	0.78	1.22	1.67
Length (mm)	391	427	462
Rate (kN/m)	12	13	16
Effective Deflection (mm)	64	94	101
Natural Freq. (Hz)	1.98	1.63	1.57
Weight (lbs.)	0.63		

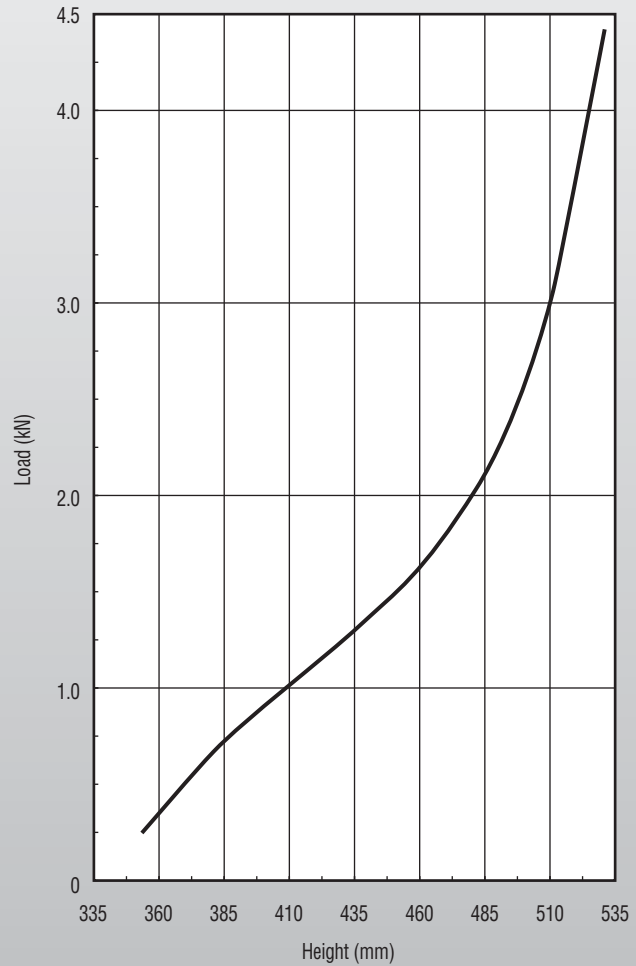
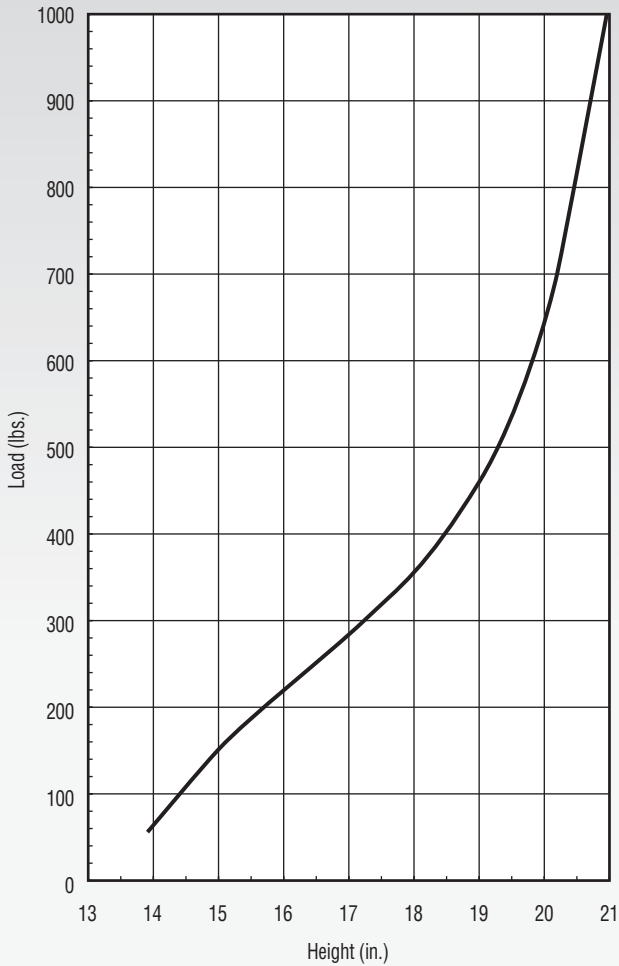
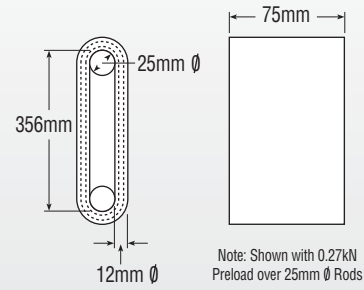

DISTRIBUTED BY:

Firestone

*World's Number 1
Air Spring.*



FIRESTONE INDUSTRIAL PRODUCTS COMPANY

www.fsip.com

800.888.0650

PLEASE NOTE:

The information contained in this publication is intended to provide a general guide to the characteristics and application of these products. The material, herein, was developed through engineering design and development, testing and actual applications and is believed to be reliable and accurate. Firestone, however, makes no warranty, express or implied, of this information. Anyone making use of this data does so at his/her own risk and assumes all liability resulting from such use. It is suggested that competent professional assistance be employed for specific applications.